



PETERSBURG NUCLEAR PHYSICS INSTITUTE NAMED BY B.P. KONSTANTINOV
OF NATIONAL RESEARCH CENTER "KURCHATOV INSTITUTE"



PNPI Scientific Highlights

2022



PETERSBURG NUCLEAR PHYSICS INSTITUTE NAMED BY B.P. KONSTANTINOV
OF NATIONAL RESEARCH CENTER "KURCHATOV INSTITUTE"



**KURCHATOV
INSTITUTE**



PNPI Scientific Highlights 2022

Gatchina • 2023

Chief-editors:

V.V. Voronin
S.V. Sarantseva
S.I. Vorobyev
V.I. Maksimov
E.V. Moskvina

Editors:

D.N. Aristov	V.V. Sarantsev
S.I. Vorobyev	M.V. Suyasova
N.N. Gubanova	A.V. Titov
A.L. Konevega	O.L. Fedin
A.I. Kurbakov	S.R. Friedmann
R.A. Niyazov	K.A. Shabalin

Proofreaders:

E.Yu. Orobets
N.V. Silinskaya
A.I. Zaitseva (translation)

Technical editing and design:

T.A. Parfeeva

Layout composition:

E.V. Veselovskaya
A.O. Pavlova

Executive in charge

S.I. Vorobyev

PNPI Scientific Highlights 2022. – Gatchina, Leningradskaya obl.:
NRC “Kurchatov Institute” – PNPI Publishing, 2023. – 126 pages.

The publication is a compilation of abstracts of the most significant results of scientific research at NRC “Kurchatov Institute” – PNPI in 2022. In addition to an abstract, each scientific result in the volume features references to the full articles of leading domestic and foreign publications, where the study is described in detail and where one can get acquainted with its full content.

Copyright © 2023 NRC “Kurchatov Institute” – PNPI

Table of Contents

7	Preface
11	Research Divisions
29	Theoretical and Mathematical Physics
41	Research Based on the Use of Neutrons, Photons, and Muons
47	Research Based on the Use of Protons and Ions. Neutrino Physics
65	Biological Research
73	Nuclear Medicine (Isotope Production, Beam Therapy, Bio- and Nanotechnologies for Medical Purposes)
77	Nuclear Reactor and Accelerator Physics
83	Applied Research and Developments
91	Basic Installations
101	Scientific and Organizational Activities



Dear colleagues, dear friends!

NRC “Kurchatov Institute” – PNPI is a multispecialized multidisciplinary research center which has been part of National Research Center “Kurchatov Institute” from the very beginning of its formation.

According to the RF Presidential Edict No. 356 of 25.07.2019 “On measures to promote synchrotron and neutron studies and research infrastructure in the Russian Federation” as well as in the framework of the national project “Science and Universities” and Federal Scientific and Technical Program for the development of synchrotron and neutron studies and research infrastructure in the Russian Federation for the period 2019–2027, NRC “Kurchatov Institute” – PNPI successfully implements various projects at the PIK Neutron Research Facility, which is a unique scientific “megascience” project. In 2022, the PIK reactor was ramped up to the power level of 10 MW. The manufacture and delivery of 20 experimental stations is actively underway.

This year, a serious step was also made in the development of nuclear medicine. In 2022, design work was completed and positive conclusions were obtained from Glavgosexpertiza of Russia for the construction of the “Isotope” radioisotope facility on the basis of the C-80 cyclotron for the development of radionuclide production methods and the production of a wide range of radioisotopes for the diagnosis and therapy of oncological, cardiovascular, neurological, and ophthalmological diseases, as well as the “Oko” onco-ophthalmological facility for the treatment of malignant neoplasms of the eye and orbit. These two facilities will become part of the Scientific and Educational Center of Nuclear Medicine – a branch of NRC “Kurchatov Institute”.

Longstanding traditions, unique scientific, technological and human resources are all indicative of the professionalism, energy, and passion for work of the powerhouse that is Kurchatov Institute!

Today NRC “Kurchatov Institute” is one of the largest and internationally recognized Russia’s research centers conducting fundamental and applied research in various fields.

Let the work of high-end professionals contribute to the prosperity and development of the Russian state and the national science in the future!



President of NRC “Kurchatov Institute” Mikhail V. Kovalchuk



МОНГОЛ УЛАМЫН
ХАМГААГА

Preface

Petersburg Nuclear Physics Institute named by B.P. Konstantinov of NRC “Kurchatov Institute” (hereinafter – the Institute) is a multidisciplinary research center that conducts fundamental and applied research in the field of particle and high-energy physics, nuclear physics, condensed matter physics, molecular and radiation biophysics.

The scientific achievements of Institute’s researchers have been awarded the Lenin and State prizes, the prizes of the Government of the Russian Federation and the Academic prizes. Three employees were elected full members and eight employees – corresponding members of the Russian Academy of Sciences (RAS). In 2022, the Institute employed 2 028 workers including 452 researchers, 66 Doctors of Sciences and 241 Candidates of Sciences. At the moment, one employee is the corresponding member of RAS, and one – professor of RAS.

The Institute consists of five research divisions sharing a common infrastructure:

- Theoretical Physics Division,
- Neutron Research Division,
- High Energy Physics Division,
- Molecular and Radiation Biophysics Division,
- Advanced Development Division.

The long-term and short-term research program of the Institute can be found in two documents, which are the Program of Activity of NRC “Kurchatov Institute” and the Institute’s Program of Research and Development (R&D) in accordance with the State assignment.

Just like other institutes within the National Research Center “Kurchatov Institute”, the Institute takes an active part in various international projects and collaborates with the largest international research centers within its main research areas.

The Institute operates and builds basic facilities for physical research. The WWR-M research reactor built in 1959 is in extended shutdown since 31 December 2015. For a long time, it was used to conduct fundamental and applied research in the field of nuclear physics, condensed matter physics, radiation materials science, radiation

biology, the production of radionuclides for medical and technical use. The proton synchrocyclotron SC-1000 celebrated the 55th anniversary of its physical startup in November 2022. Works are underway to create the radioisotope complex “Isotope” based on the isochronous cyclotron C-80. The facility is aimed at the development of radionuclide production methods and production of a wide range of radioisotopes for diagnostics and therapy of oncological, cardiovascular, neurological, and ophthalmological diseases. Another C-80 based facility which is being created is the “Oko” proton therapy facility for the treatment of ocular cancer.

In 2022, works on the implementation of investment projects on modernization and renovation of engineering systems of PIK neutron facility continued. Undoubtedly, this year was an important milestone on the way to the establishment of the PIK research facility – the PIK reactor ramped up to the power level of 10 MW. The manufacture and delivery of 20 experimental stations is actively underway. NRC “Kurchatov Institute” – PNPI still faces an ambitious task to implement a world-class project – the creation of the International Center for Neutron Research (ICNR) on the basis of the high-flux research reactor PIK.

The project of creation of ICNR on the basis of high-flow reactor PIK is implemented within the framework of the national project “Science and Universities” and in accordance with the Decree of the President of the Russian Federation of 25.07.2019 No. 356 “On measures to promote synchrotron and neutron studies and research infrastructure in the Russian Federation”, as well as within the activities of the Federal Scientific and Technical Program for the development of synchrotron and neutron studies and research infrastructure in the Russian Federation for the period 2019–2027.

The implementation of the ICNR project on the basis of the PIK research facility, the power start-up of the PIK reactor for fundamental and applied neutron research will increase and strengthen



the role of Russian research projects and scientists in international scientific and technical cooperation. The implementation of the ICNR project on the basis of the PIK facility will enable conducting research on the properties of magnetic materials and biological objects, obtaining new knowledge about the properties of exotic nuclei and fundamental interactions, and developing new technologies to study the dynamics and distribution of neutron flux.

In 2022, the Institute hosted over 15 socially significant events (meetings, conferences, and schools). The most remarkable of them were: VI Workshop on Inelastic Neutron Scattering “Spectrina-2022”, VIII International Conference and XIV International School for Young Scientists and Specialists Named after A.A. Kurdyumov “Interaction of Hydrogen Isotopes with Structural Materials”, II Summer School of the Council of Young Scientists and Specialists of NRC “Kurchatov Institute” – PNPI, V School “Neutron Studies of Condensed Matter” (“NIKONS-2022”), IX All-Russian Youth Science Forum with International Participation Open Science 2022, VII Youth School of the PIK Reactor (Professionalism. Intellect. Career. “PIK-2022”), XI School on Polarized Neutron Physics “FPN-2022”, etc.

In 2022, the second graduation from the Institute’s postgraduate program took place. Six graduation diplomas of postgraduate program were issued, which certify a successful completion of the third level of higher education in four fields of science (under the federal state educational

standard (FSES) of the higher education): “Theoretical Physics” (one diploma), “Condensed Matter Physics” (one diploma), “Nuclear and Particle Physics” (one diploma), “Genetics” (three diplomas).

In 2022, thirteen students entered a full-time postgraduate course: eight students for the group of scientific specialties 1.3. “Physical Sciences” and five students for the group of scientific specialties 1.5. “Life Sciences”.

In 2022, more than 240 students of Russia’s universities conducted academic and research work, did practical training, prepared final qualification works for Bachelor’s and Specialist’s degree and Master theses in the laboratories of the Institute.

This publication is a collection of brief descriptions of the most significant and important research results of NRC “Kurchatov Institute” – PNPI obtained in 2022. This description is preceded by reviews of the heads of Institute’s scientific divisions. It is followed by abstracts of papers, the presentation of which was discussed and recommended by scientific councils of the divisions. In addition to an abstract, each research result contains references to articles in leading Russian and foreign journals, describing the study in detail and where its full content can be found.

The results of the work of the Institute’s researchers were published in more than 600 research papers, including 380 papers in peer-reviewed journals indexed by Web of Science and Scopus databases, and around 470 reports were presented at more than 180 international and Russian conferences.

The final section contains general information about the Institute.



Director of NRC “Kurchatov Institute” – PNPI
Sergey E. Gorchakov

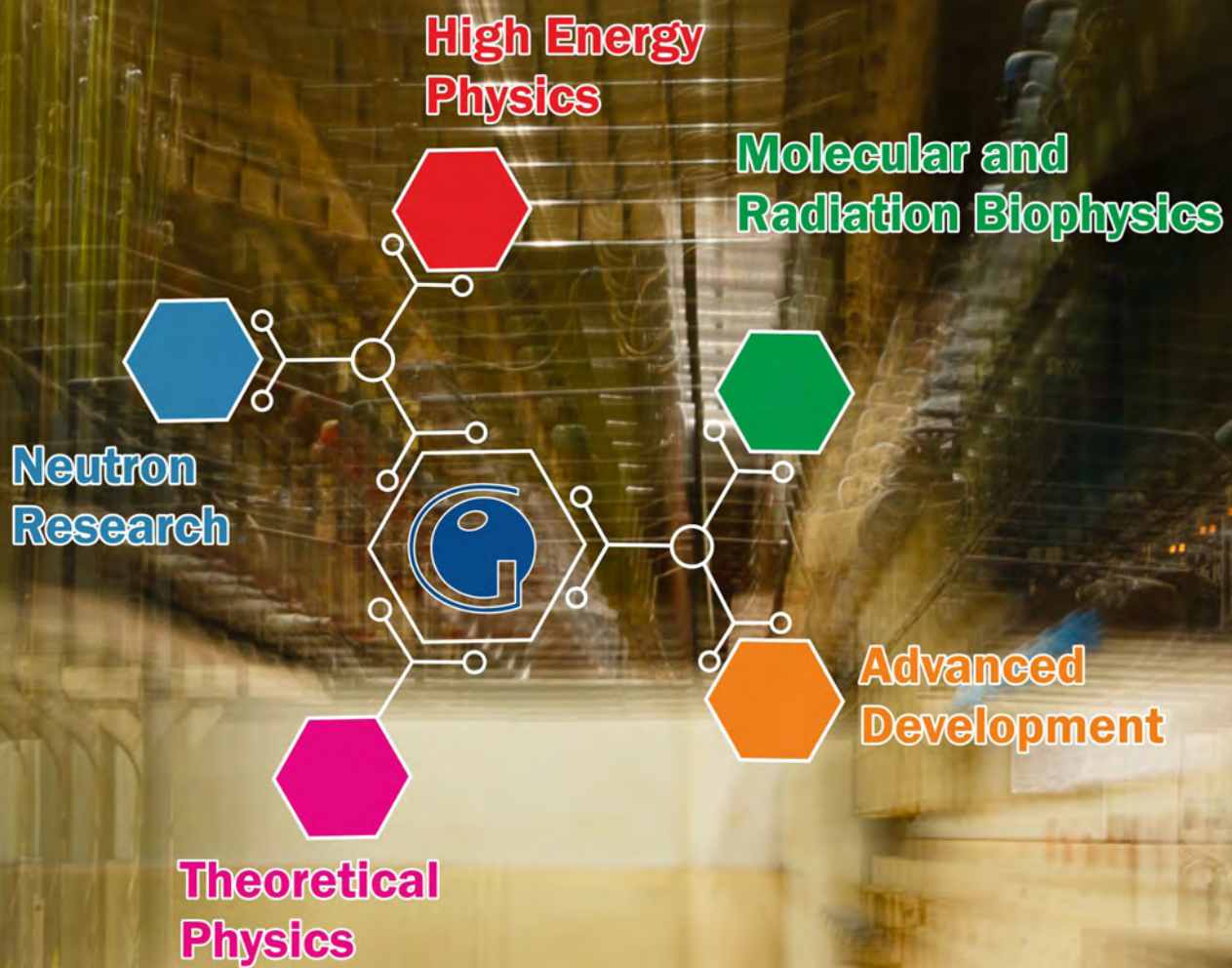

Research Divisions

- 12** Theoretical Physics Division
- 14** Neutron Research Division
- 18** High Energy Physics Division
- 21** Molecular and Radiation Biophysics Division
- 24** Advanced Development Division

Theoretical Physics Division

Theoretical Physics Division (TPD), headed by Dr. D.N. Aristov, consists of six departments:

- Strong Interactions Theory (headed by Dr. K.M. Semenov-Tian-Shansky);
 - Quantum Field Theory (headed by Dr. V.A. Kudryavtsev);
 - Particle Phenomenology (headed by Dr. A.V. Sarantsev);
 - High Energy Physics (headed by Dr. A.V. Yung);
 - Condensed Matter Theory (headed by Dr. D.N. Aristov);
 - Theoretical Nuclear and Atomic Physics (headed by Dr. A.I. Mikhailov)
- and the Group of Nuclear Reactor Theory (headed by Dr. M.S. Onegin).

TPD employs 50 research staff members (18 Doctors of Sciences and 26 Candidates of Sciences).



Dr. D.N. Aristov,
head of the TPD

The research carried out at the TPD covers most areas of modern theoretical physics – from elementary particle physics and quantum field theory to the physics of nuclear reactors.

One of the traditional topics of research in the TPD is the study of scattering at high energies. For a long time, the work of the TPD scientists determined the world level in this field. In the work of M.G. Ryskin with co-authors the exclusive production of J/ψ mesons was analyzed at the energies of the Large Hadron Collider. It has long been proposed to use this process as a way to measure the gluon structure function very accurately at small x . The collection of papers below includes a 2022 paper, where it was also proposed to use data on Y -mesons to obtain information on the distributions of gluons at very small x and different energies.

The hypothesis of the so-called AdS/CFT duality (anti-de Sitter/conformal field theory) has attracted much attention from theorists, and the TPD is one of the world leaders in this field. The duality

means that a non-trivial field theory ($N = 4$ supersymmetric Yang–Mills theory) in four-dimensional space-time is equivalent to some string theory in anti-de Sitter space and both approaches are exactly solvable. In fact, the duality is expressed in the connection between the anomalous dimensions of the operators in the supersymmetric theory and the spectrum of the string in the anti-de Sitter space. In the works of 2022, the analysis of the anomalous dimension of the twist-2 operators was continued, which is important for testing the AdS/CFT hypothesis. A generalized doubly logarithmic equation was obtained, which can lead both to predictions for the analytically continued anomalous dimension and to the reconstruction of the general form of the anomalous dimension from the already available results.

Previously, it was shown that a soliton non-Abelian vortex tube (string) in $N = 2$ supersymmetric quantum chromodynamics (QCD) behaves like a critical superstring. Moreover, the states of a closed superstring arising in four dimensions are identified with the hadrons of such supersymmetric QCD. In 2022, the response of this string to the existence of nonzero quark masses into four-dimensional QCD was studied. It is shown that the finite mass effect reduces to a non-zero flow of the Neveu–Schwarz 3-form through a 3-sphere on a conifold. The solution of the resulting equations shows that the conifold degenerates into a space of lower dimension, and an Abelian the-

ory with two quark flavors arises. Theoretical analysis will be continued.

Among the works of the TPD in the field of the theory of condensed state, one can note a series of papers devoted to the analysis of elementary excitations in the noncollinear quantum magnets. One of such well-known systems is the Heisenberg antiferromagnet with spin $1/2$ on a triangular lattice, for which the available theoretical approaches are unsatisfactory. In 2022, the dynamic properties of this model were studied by a new, especially developed method. Good agreement with the available numerical and experimental data is demonstrated.

Noncollinear magnets are considered to be promising materials for creating new devices, in particular memory devices. In recent years, magnetic skyrmions and their ordered arrays, skyrmion crystals, have been actively studied. In 2022, TPD researchers proposed a description of a skyrmion crystal in the form of a sum of stereographic projections for single skyrmions. The magnetic dynamics of such a crystal is studied, and the band structure of the magnon spectrum in a skyrmion superlattice is numerically found.

The use of noncollinear magnets implies the knowledge of model parameters to describe them. In 2022, a small-angle neutron scattering method was proposed to experimentally determine these parameters. The magnon spectrum was calculated in the fully polarized phase in the presence of a magnetic field and the Dzyaloshinskii–Moriya interaction of the interface type. A number of scattering features are revealed depending on the orientation of the applied field, and it is shown that the scattering maps observed in the experiment are directly related to the parameters of the microscopic model used to describe such systems.

In 2022, TPD researchers published 49 research papers in peer-reviewed journals indexed by Web of Science and Scopus databases, presented 38 reports at international and Russian conferences, delivered eight courses of lectures at Saint Petersburg University, Alferov Saint Petersburg National Research Academic University of RAS and National Research University “Higher School of Economics”; one postgraduate student of the Institute was hired at the TPD.

Neutron Research Division

Neutron Research Division (NRD), headed by Dr. A.I. Kurbakov, consists of four departments. Neutron Physics Department (headed by Corresponding Member of RAS Dr. A.P. Serebrov) consists of four laboratories:

- Neutron Physics Laboratory (headed by Corresponding Member of RAS Dr. A.P. Serebrov);
- X- and γ -Ray Spectroscopy Laboratory (headed by Dr. V.V. Fedorov);
- Nuclear Spectroscopy Laboratory (headed by Dr. I.A. Mitropolsky);
- Molecular and Atomic Beams Laboratory (headed by Dr. V.F. Ezhov)

and two groups:

- Weak Interaction Research Group (headed by Dr. A.N. Pirozhkov);
- Nuclear Fission Physics Group (headed by A.M. Gagarsky).

Condensed Matter Research Department (headed by Dr. I.A. Zobkalo) consists of four laboratories:

- Disordered State Physics Laboratory (headed by Dr. N.N. Gubanova);
- Crystal Physics Laboratory (headed by Dr. Yu.P. Chernenkov);
- Materials Research Laboratory (headed by Dr. A.I. Kurbakov);
- Neutron Physical and Chemical Research Laboratory (headed by Dr. V.T. Lebedev)

and Condensed Matter Electrodynamics Group (headed by Dr. O.V. Gerashchenko).

Semiconductor Nuclear Detectors Department (headed by Dr. A.V. Derbin).

Operation of Neutron Stations at the PIK Reactor Department (headed by Dr. V.V. Tarnavich).

NRD employs 167 research staff members (11 Doctors of Sciences and 48 Candidates of Sciences).



Dr. A.I. Kurbakov,
head of the NRD

The main directions of the NRD scientific activity are fundamental studies in the field of nuclear and elementary particles, and condensed matter physics. The neutron is a very

convenient research tool because it is involved in all types of interactions currently known. The purpose of the research carried out in the NRD is the development and widespread introduction of methods and technical resources primarily using neutron radiation to study the composition, structure and fundamental properties of matter, predict, create and analyze the properties of new materials, and new physical phenomena in them, develop domestic unique experimental facilities and analytical techniques for neutron research.

The NRD is the main executor at NRC “Kurchatov Institute” – PNPI of the thematic area No. 7 “Research in the Field of Neutron Physics” of the Program of Activities of NRC “Kurchatov Institute”. The employees of the division participate as performers in the implementation of some other areas of this Program.

The development and creation of the instrument suite of the PIK reactor facility is currently at the forefront. Scientists and engineers of the NRD are now developing new physical instruments for PIK facility, creating the first stage installations, completing the design and already starting to create some systems of the second and third stage instruments.

The physical installations created for the PIK reactor facility can be conditionally divided into two categories: nuclear physics instruments and condensed matter physics instruments. Nuclear physics facilities are a source of ultracold neutrons, “Neutrino” installation, “Neutron β -Decay” facility, FISCO fission fragment multiplicity study facility, DEDM facility (neutron EDM by crystal diffraction

method), neutron radiation analysis (INAA), nuclear radiation spectrometer PROGRAS, IRINA facility for the study of radioactive isotopes on neutrons.

Condensed matter physics instruments can be classified according to the use of different types of neutron scattering on a sample. These are neutron inelastic scattering spectrometers IN-1, IN-2 using cold neutrons, IN-3 using polarized neutrons; small-angle scattering instruments TENZOR and MEMBRANA; spin-echo spectrometers SESANS and SEM; powder diffractometers D1 and D3 and single-crystal diffractometer DC-1; reflectometers HARMONY and SONATA.

2022 was a successful year as far as the scientific results and achievements are concerned. At the competition for the best scientific works of NRC “Kurchatov Institute” – PNPI, research teams, in which the main performers were NRD scientists, received four first, two second and four third awards. The research cycle “Search for a sterile neutrino in the experiment “Neutrino-4” and measurement results” A.P. Serebrov and others was recognized as the best work of the Institute. The Division has never achieved such success in the competition of the best works (11 awards) before. In addition to the main activity for the implementation of the thematic plan of NRC “Kurchatov Institute” – PNPI, scientific research was carried out within the framework of two projects of the RFBR and six projects of the RSF, in which the leaders were scientists from the NRD. A great achievement of the NRD in the current difficult situation was the organization and holding in 2022 of four scientific schools and conferences.

In the field of research of the fundamental properties of matter NRD scientists together with their colleagues have obtained quite a lot of new important results in 2022.

In the scientific direction of condensed matter physics, using research methods including neutron scattering of different types, various other physical techniques, numerical simulation, and theoretical calculations, the following main results were obtained.

The parameters of magnetic interactions, the field and temperature evolution of the magnetic structures of $R\text{FeO}_3$ compounds demonstrating

significant magnetoelectric interplays determined using the methods of diffraction and inelastic neutron scattering. In 2022, the parameters of magnetic interactions in TbFeO_3 were obtained and a significant difference was shown between the isotropic exchange energy of the nearest Fe^{3+} ions in the ab plane and in the c direction. The temperature variations of the magnetic anisotropy for different phases in TbFeO_3 and YbFeO_3 are shown. The magnetic phase diagrams of YbFeO_3 was constructed (Crystal Physics Laboratory headed by Dr. Yu.P. Chernenkov, Dr. I.A. Zobkalo).

The parameters driving the magnetic structure and dynamics of an entire class of noncentrosymmetric cubic helimagnets with the Dzyaloshinskii–Moriya (DM) interaction were established. Small-angle scattering of polarized neutrons was developed to measure the stiffness of spin waves in helimagnets. In 2022, $\text{Fe}_{1-x}\text{Co}_x\text{Si}$ helimagnets were studied and a theory was proposed that clarifies the Bak–Jensen model, in which the predominance of crystallographic anisotropy over DM interaction leads to ferromagnetic ordering in the system. Scenarios for this transition are described depending on the temperature and magnetic field near x_c (Disordered State Physics Laboratory headed by Dr. N.N. Gubanov, Dr. S.V. Grigoriev).

The features of magnetic properties of RMn_2O_5 and RMnO_3 multiferroics (R is a rare-earth element) at the microscopic level were studied by the methods of polarized and unpolarized neutron diffraction. In 2022, it was shown that there is also a strong R -Mn interaction in DyMnO_3 , which provides the “manganese – driven” and “dysprosium – driven” modes for the magnetically ordered phase, as well as unusually long processes of relaxation of the magnetic structure. The obtained results have the generality necessary to construct theoretical models of improper multiferroics and to predict the creation of new functional materials (Crystal Physics Laboratory, Dr. I.A. Zobkalo).

The study of the mechanisms of formation of long-range magnetic order in layered oxides with a triangular superstructure of magnetic ions by the method of diffraction of unpolarized neutrons was continued. In 2022, the types of magnetic ordering in the ground state of strongly frustrated

layered tellurates A_2MTeO_6 with honeycomb crystal and triangular magnetic superstructures in one layer were determined (Materials Research Laboratory headed by Dr. A.I. Kurbakov).

The study of biogenic magnetic structures of magnetotactic bacteria is aimed at elucidating the mechanism of orientation of some species of unicellular organisms in the Earth's magnetic field and developing a biotechnology for the production of biogenic magnetic nanoparticles (magnetosomes) for theranostics of a number of diseases. In 2022, data on the nonlinear magnetic response of magnetosomes for six cultures of magnetotactic bacteria were processed. The estimates of their magnetic parameters were obtained. A two-mode nature of the distribution over magnetic moments was found. The presence of two fractions is associated with the degradation of the initial magnetic chains. Changes in the state of magnetosomes during long-term storage of bacteria are shown (Condensed Matter Electrodynamics Group headed by Dr. O.V. Gerashchenko, V.V. Deriglazov).

Synthesis and certification of carbon cryogel were carried out (Disordered State Physics Laboratory, G.P. Kopitsa). Carbon cryogel obtained by a three-stage synthesis, including the formation of a gel from a mixture of resorcinol-formaldehyde resins, followed by freeze drying and pyrolysis in nitrogen at 800 °C, was studied by complementary methods: X-ray diffraction, Raman spectroscopy, IR-Fourier spectroscopy, differential thermal and thermogravimetric analysis, scanning electron microscopy, helium pycnometry, low temperature nitrogen adsorption, small angle X-ray scattering, and small angle neutron scattering (SANS). The possibilities of using the contrast variation method in SANS to study the porous structure of materials based on cryogels, aerogels, pyrogels, etc. were demonstrated.

A new generation of Aquivion®-type composite membranes with additives of the detonation nanodiamond (DND) particles for hydrogen fuel cells was proposed and studied (Neutron Physical and Chemical Research Laboratory, Dr. Yu.V. Kulvelis). Electrochemical studies of membranes as part of membrane-electrode blocks also showed the best characteristics at 0.5 wt. % DND,

significantly exceeding the parameters of the unmodified membrane (without diamonds).

An experimental proof of the logarithmic fractal structure of botanical trees is proposed. Once upon a time, without knowing anything about fractals, Leonardo da Vinci formulated the law of tree growth, according to which the cross-sectional area of branches below a given branching point is equal to the sum of cross-sectional areas of child branches above this branching point. The authors of this work used the method of numerical Fourier analysis, which Leonardo, of course, also knew nothing about, to identify logarithmic fractal properties of two-dimensional objects, and then applied it to study the structure of real trees using their photographs. As a result, it is shown that the structure of a tree is determined by the law of conservation of the lateral surface area of branches before and after branching, which means that the life of a tree "flows" along the surface of the tree, or, the tree lives according to the laws of two-dimensional space, and Leonardo's law should be either modified or supplemented (Disordered State Physics Laboratory, Dr. S.V. Grigoriev).

In the field of nuclear physics in 2022 the NRD scientists also obtained a number of new important results.

The result of the "Neutrino-4" experiment and the results of other experiments on the search for sterile neutrino were analyzed. The contribution to the energy density of the Universe of sterile neutrinos with the parameters $m_{14}^2 = 7.3 \text{ eV}^2$ and $\sin^2 2\theta_{14} = 0.33$ measured in the "Neutrino-4" experiment was rated. The problem of the contradiction between the measured parameters of the sterile neutrino and the observed cosmological constraints was discussed (Neutron Physics Laboratory, Dr. A.P. Serebrov).

In the search for resonant absorption of solar axions by ^{83}Kr nuclei, new data for the axion-electron coupling constant g_{Ae} were obtained jointly with the Institute for Nuclear Research of RAS, based on the results of an experiment at the Baksan Neutrino Observatory. The achieved sensitivity for axion masses $\sim 1 \text{ keV}$ is record high and is close to astrophysical limitations. The NRD staff searched for neutrino events in

the Borexino detector in correlation with 74 gravitational events (GE) recorded by the LIGO, Virgo detectors. Signals with energies > 250 keV were analyzed in a window of ± 1000 s corresponding to the GE registration time. No statistically significant excess over the background was observed. As a result, the most stringent upper limits on GE-associated neutrino fluences of all flavors have been obtained for neutrinos with energies 0.5–5 MeV. Together with the participants of the Borexino international collaboration in 2022, new results were obtained on the registration of neutrinos from the CNO cycle on the Sun. The group from NRC “Kurchatov Institute” – PNPI performed precision measurements of the ^{210}Bi β -spectrum, the results of which were used to determine the contribution to the background of Borexino from ^{210}Bi in the analysis of signals from CNO neutrinos. The results were obtained using two types of β -spectrometers (Semiconductor Nuclear Detectors Department, Dr. A.V. Derbin).

Red supergiants are the largest of the stars (a mass of about 5–100 solar masses). Their existence ends with a type II supernova explosion, leaving behind only a black hole or neutron star. The work was stimulated by the fact that in order to study the process, it is necessary to measure the temperature change of red supergiants before their explosion. It was proposed to measure the temperature of electrons by comparing the relative intensity of two lines. One of the most persistent and intensively studied problems of X-ray astronomy is the disagreement between modern theory and observations for the intensity ratio of two Fe XVII transitions of crucial value for plasma diagnostics, called 3C and 3D. Scientists discovered the explosion of a red supergiant on September 16,

2020. The precursor star of the supernova named SN 2020tlf was watched during its last 130 days. Researchers used telescopes at the Keck Observatory on Hawaii Island and compared the celestial event to a “ticking time bomb” ready to explode at any time. The current experimental ratio $R_{\text{exp}} = f_{3\text{C}}/f_{3\text{D}} = 3.51(2)_{\text{stat}}(7)_{\text{sys}}$ is consistent with the calculated $R_{\text{th}} = 3.55(2)$ as well as with some previous theoretical predictions. To further exclude any uncertainties associated with the measured ratio, individual natural linewidths and oscillator values for the 3C and 3D transitions were also identified, which are also in good agreement with theory. This finally resolves the long-term mystery of Fe XVII oscillators (Laboratory of Molecular and Atomic Beams headed by Dr. V.F. Ezhov, Dr. V.G. Kozlov).

The distribution of uranium isotopes in solutions at the boundary of a polar and non-polar medium was studied to create a γ -spectroscopic method for determining the content of uranium isotopes in extraction–adsorption processes. A novel method for the chemical enrichment of uranium for light isotopes based on the extraction of uranium in an acidic medium with a polar organic extractant is proposed. At the interface between the polar and non-polar medium, uranium isotopes are distributed in height according to their atomic number (Nuclear Spectroscopy Laboratory headed by Dr. I.A. Mitropolsky, Dr. V.G. Zinoviev).

In 2022, the research staff of the NRD published 69 research papers in peer-reviewed journals indexed by Web of Science and Scopus databases, obtained one certificate of state registration of specialized programs.

High Energy Physics Division

High Energy Physics Division (HEPD), headed by Dr. O.L. Fedin, consists of nine laboratories:

- Elementary Particle Physics (headed by Dr. V.T. Kim);
- Relativistic Nuclear Physics (headed by Dr. Yu.G. Ryabov);
- Short-Lived Nuclei (headed by Dr. V.N. Panteleev);
- Meson Physics (headed by Dr. S.I. Vorobyev);
- Crystal Optics of Charged Particles (headed by Dr. Yu.M. Ivanov);
- Hadron Physics (headed by Dr. O.L. Fedin);
- Physics of Exotic Nuclei (headed by Dr. Yu.N. Novikov);
- Baryonic Physics (headed by Dr. A.A. Dzyuba);
- Cryogenic and Superconductive Techniques (headed by Dr. A.A. Vasilyev)

and four technical departments:

- Radio Electronics (headed by Dr. V.L. Golovtsov);
- Tracking Detector (headed by Dr. A.G. Krivshich);
- Computing Systems (headed by A.E. Shevel);
- Muon Chambers (headed by V.S. Kozlov).

HEPD employs 97 research staff members (13 Doctors of Sciences and 50 Candidates of Sciences).



Prof. O.L. Fedin,
head of the HEPD

The HEPD activity is mainly aimed at experimental research in the field of elementary particle physics and nuclear physics. In addition, the development of innovative

methods for obtaining radioisotopes for medical applications and the study of magnetic properties of materials with the use of the μ SR-method are being performed. As in previous years, research works were conducted at facilities of NRC “Kurchatov Institute” – PNPI and at accelerators of the world’s leading nuclear centers.

In 2022, the following experiments were carried out.

1. At the synchrocyclotron of NRC “Kurchatov Institute” – PNPI:

- Production and studies of short-lived nuclei with the isotope mass separator on-line facility IRIS;

- Studies of polarization effects in proton quasi-elastic scattering off nuclei;

- Studies of magnetic properties of materials with μ SR-method,

as well as at other installations of the Institute:

- The PolFusion experiment to study the thermonuclear fusion reaction of polarized deuterium nuclei;

- Creation of an experimental setup for studying the properties of the unique ^{229}Th isomer (supported by the RSF grant No. 22-22-00090), which is a candidate for creating a new frequency standard.

2. At the European Center for Nuclear Research (CERN):

- Participation in CMS, ATLAS, LHCb, and ALICE experiments at the Large Hadron Collider (LHC);

- Production and studies of short-lived nuclei with the isotope mass separator on-line facility ISOLDE;

- Studies of possibilities to use crystal collimation of the LHC beams (experiment UA9).

3. At the meson factory at the Paul Scherrer Institute (Switzerland) – search for muonic catalysis of the nuclear fusion reaction $d^3\text{He}$.

4. At the GSI Helmholtz Center for Heavy Ion Research (Darmstadt, Germany) – measurement of the masses of superheavy elements at the SHIPTRAP installation (Penning trap).

5. At the Max Planck Institute for Nuclear Physics (Heidelberg, Germany) – ultraprecise measurement of the mass difference of ^{187}Re – ^{187}Os , which is necessary to determine the effective mass of antineutrinos with the PENTATRAP Penning trap.

The experiment MuSun (high precision studies of muon capture on the deuteron) was completed at the Paul Scherrer Institute meson factory (Switzerland), the data analysis continues.

New HEPD projects include preparations of the following experiments:

- “Proton” for measurements of the proton charge radius in elastic electron–proton scattering at the electron accelerator MAMI (Mainz, Germany);
 - AMBER/NA66 for measurements of the proton charge radius in elastic muon–proton scattering on the SPS beam at CERN;
 - R3B, MATS, PANDA, CBM at the accelerator complex FAIR (Helmholtz Center for Heavy Ion Research, Germany);
 - SHiP for search of new particles from hidden sector at CERN;
 - MPD and SPD at the NICA collider under construction now in Dubna,
- as well as the following projects:
- IRINA for production and studies of short-lived nuclei at the PIK high-flux neutron reactor;
 - PITRAP for precision mass measurements of short-lived nuclei at the PIK high-flux neutron reactor;
 - RIC-80 for production of radioisotopes for medical applications.

One of the main activities of the HEPD is the participation in fundamental research at unique accelerator facilities in world scientific centers, such as the LHC at the CERN and at the new-generation accelerator research facility at the European Facility for Antiproton and Ion Research (FAIR).

At the CERN, the HEPD has participated in the LHC experiments CMS, ATLAS, LHCb, and ALICE from the initial stages of design and construction of these detectors with a significant intellectual and instrumental contribution to various

subsystems of these detectors. After the LHC start-up, HEPD physicists and engineers, along with other participants in the experiments, have shared responsibilities in maintenance and operation of these detectors and taken part in the analysis of the experimental data. The analysis of the experimental data collected in Run 2 (2015–2018) continues to yield a great number of new results.

The most significant of them, obtained in 2022, with the participation of staff of the Division, are the refinement of the interaction constants of the Higgs boson with fermions (quarks and leptons) in the ATLAS and CMS experiments, the measurement of the cross section for the interaction of antihelium-3 with matter in the ALICE experiment, an indication of *CP*-violation effects in the decays of *B*- and *D*-mesons in the LHCb experiment. Over the entire period of operation of the LHCb experiment, 60 new hadronic states have been discovered, among which there are candidates for penta- and tetraquark states.

In 2022, the major activities of the HEPD groups participating in the LHC experiments were focused on the commissioning of the CMS, ATLAS, LHCb и ALICE detectors after their modernization to be able operate at Run 3 after increasing LHC collider luminosity. The HEPD groups actively participated in the modernization of detectors. The thin-gap chambers for the forward part of the ATLAS muon spectrometer and the new muon chambers with improved granularity for the LHCb experiment were created at NRC “Kurchatov Institute” – PNPI. The high-voltage power supplies of the CMS muon system, which was previously created at the Institute, was modernized. The start of all four detectors at the LHC collider was successfully carried out, and the uninterrupted operation of all subsystems, for which the HEPD groups were responsible, was ensured during the data collection in 2022.

One of the fundamental tasks carried out in the HEPD is the study of the properties of nuclear matter in collisions of heavy ions. The implementation of this task began in the 1980s in the PHENIX experiment (Brookhaven National Laboratory, USA) and continued in the ALICE experiment (CERN). In connection with the construction

of the collider NICA (Nuclotron-based Ion Collider Facility) in Dubna, aimed at studying nuclear matter in ion–ion collisions, the Division became involved in the creation of a multipurpose MPD detector and the development of a physical program for the experiment. The HEPD is also involved in the design development of the concept and physical research program for the second SPD de-

tector at the NICA collider, which aims to study polarized particle collisions to investigate the spin structure of the nucleon.

In 2022, the research staff of the HEPD published 160 research papers in peer-reviewed journals and presented 31 research reports at international and Russian events.

Molecular and Radiation Biophysics Division

Molecular and Radiation Biophysics Division (MRBD), headed by Dr. A.L. Konevega, consists of four laboratories:

- Experimental Genetics (headed by Dr. S.V. Sarantseva);
- Human Molecular Genetics (headed by Dr. S.N. Pchelina);
- Molecular Biophysics and Neutron Research (headed by Dr. A.L. Konevega);
- Biotechnology (headed by Dr. A.A. Kulminskaya);

three centers:

- Preclinical and Clinical Research Center (headed by Dr. A.P. Trashkov);
- Resource Center (headed by Dr. N.A. Verlov);
- Kurchatov Genomic Center (headed by Dr. A.A. Kulminskaya)

and the Engineering Support Department (acting principal engineer – P.A. Sotnikov).

MRBD employs 114 research staff members (11 Doctors of Science and 47 Candidates of Science).



Dr. A.L. Konevega,
head of the MRBD

The main activities of the MRBD are fundamental and applied research in molecular biology, biophysics and biochemistry, structural biology, molecular and medical genetics, and

nuclear medicine. As a result of the reorganization in 2022, the scientific potential of the Division was consolidated into seven scientific units: four laboratories and three centers.

Nuclear medicine is one of the intensively developing areas of the MRBD activity. The unique infrastructure of NRC “Kurchatov Institute” – PNPI, which unites two research reactors, two accelerators, a complex of biomedical research, a center for preclinical and clinical research, and a complex for radioactive waste management on a single scientific and technical site, makes it possible to carry out a full cycle of development and production of radiopharmaceuticals, including prospecting research and development of carrier molecules, development of nuclear technologies for

the production and purification of radioactive isotopes for medical use, and production of radioactive isotopes.

Within the framework of the Federal Scientific and Technical Program of Neutron and Synchrotron Research NRC “Kurchatov Institute” – PNPI is the head organization implementing the project “Development of a domestic innovative theranostic preparation based on terbium isotopes for radioimmune therapy of malignant neoplasms of various histological types”. The project is implemented in collaboration with NRC “Kurchatov Institute”, Peter the Great Saint Petersburg Polytechnic University and Lomonosov Moscow State University. The project includes a whole range of activities aimed at creating conditions for the production of radioisotopes on the domestic production base, developing biomolecular vectors for targeted delivery of radionuclides to tumors, creating a radiopharmaceutical based on them, conducting preclinical research, and intensive training of young personnel for nuclear medicine. In 2022, the conditions for production and separation of ^{152}Tb and ^{161}Tb radioisotopes were optimized, an original technique for extraction and chromatographic separation of these isotopes on commercially available sorbents was developed, a new scheme of ^{152}Tb production by irradiation of tandem tar-

get ^{151}Eu on the U-150 isochronous cyclotron was implemented, making it possible to increase the efficiency of using the α -particle beam, and pilot production of ^{124}I isotope was launched. The antitumor activity of a preparation based on a monoclonal antibody against vascular endothelial factor receptor type 1 – anti-VEGFR1 and radioactive isotope ^{161}Tb was demonstrated on animal models, and a significant basis for production and testing of targeting bioconjugates was created.

The Kurchatov Genomic Center (KGC–PNPI), which was established several years ago as part of the Federal Scientific and Technical Program for the Development of Genetic Technologies, continues its productive work in the Division. In 2022, a number of both fundamental and applied results in the field of genetics and biotechnology were achieved at the KGC–PNPI. As part of the work on the study of recombination mechanisms in biotechnologically important unicellular microorganisms, the successes achieved in targeted editing of nuclear genes of the green algae *Chlamydomonas reinhardtii* using such genome editing tools were analyzed and summarized, such as CRISPR-Cas nucleases, zinc finger nucleases (ZFNs) and effector nucleases like transcription activators (TALEs), a protocol for editing the genes of the green algae *C. reinhardtii* using preassembled CRISPR-Cas9 ribonucleoproteins.

The search and identification of microorganisms – producers of enzymes involved in the degradation and modification of various organic polymers were continued at KGC–PNPI. Thus, in 2022 the results of screening of microorganisms – producers of xanthanolytic complex were summarized and a biocatalyst for xanthan degradation was developed on the basis of cells of symbiotic mixture immobilized in polyvinyl alcohol cryogel containing bacteria *Paenibacillus spp. Cellulosimicrobium cellulans*, which can find application in oil and food industries. A search for microorganisms that can degrade a wide range of plastic wastes has been undertaken.

A study of the effect of brown algae extract *Fucus vesiculosus*, lichen extract *Cetraria islandica* and their mixture in fermented green tea on the microbiome of the symbiotic culture SCOBY and biochemical properties of kombucha showed the potential

of algae and lichens as functional additives to produce non-alcoholic fermented beverages with additional nutraceutical value.

The study of biomineralization mechanisms showed the key role of extracellular DNA in the induction of calcium carbonate deposition during the growth of planktonic culture of *Bacillus subtilis*, associated with the formation of individual components of the extracellular matrix (extracellular DNA, amyloid proteins and polysaccharides); protein targets were identified for further development of technology to inhibit or activate the process of biomineralization and biofilm formation.

Research continued in the Laboratory of Human Molecular Genetics to search for markers of various diseases. A sensitive marker of Parkinson's disease (PD), hexasylsphingosine (HexSph), a mixture of glucosylsphingosine and galactosylsphingosine, was found, which can be considered as a biomarker of PD development in carriers of mutations in the *GBA1* gene (encodes the lysosomal enzyme glucocerebrosidase). HexSph concentration can also be considered as a potential biomarker of dementia with Lewy bodies and multiple system atrophy.

The expression of the human SNCA gene encoding α -synuclein protein and its forms with A30P and A53T mutations in *Drosophila melanogaster* was studied in the laboratory of experimental genetics. It was shown that the development of neurodegeneration depends on the duration of SNCA gene expression. Expression of the gene for a longer period of time causes death of dopaminergic neurons and reduction of dopamine level. The study of the effect of SNCA gene expression trigger and suppression on the development of neurodegenerative process in *D. melanogaster* is necessary to understand the onset and development of pathological changes in PD and other synucleopathies, as well as to determine the time intervals of “therapeutic windows” when the applied therapy will be effective.

The Laboratory of Molecular Biophysics and Neutron Research has studied the structural characteristics of the “myeloperoxidase–ceruloplasmin–thrombin” complex using small-angle neutron scattering techniques combined with computer modelling. Myeloperoxidase (MPO) is a dimeric

heme-containing enzyme of neutrophils and monocytes involved in innate immunity reactions. Excess ceruloplasmin in blood is known to suppress its activity; however, during inflammation, MPO activity is preserved due to possible partial proteolysis of ceruloplasmin by thrombin. In this study, a full-atomic model of heterohexamer was constructed *in silico* taking into account glycosylation of its constituent proteins and a structural model of heterohexamer was obtained by small-angle neutron scattering.

The use of binary technologies, in which the damaging effect of radiation is additionally enhanced by the preliminary selective accumulation of radiosensitizers in the target tissue, can significantly increase the efficiency of radiation therapy methods. An attractive mechanism of dose enhancement is the proton capture reaction by the ^{11}B atom ($^{11}\text{B} + p \rightarrow 3\alpha + 8.7 \text{ MeV}$). However, as a result of the study of the sensitizing potential of sodium borocaptate ($(\text{B}_{12}\text{H}_{11}\text{SH})\text{Na}_2$, BSH) under proton irradiation at the Bragg peak, it was proved that BSH provides only a slight enhancement of the effect of proton radiation on cancer cells *in vitro* both under irradiation with protons with energy of 200 MeV at the synchrotron C-1000, and 90 MeV at the medical proton accelerator, which confirms the insufficient efficiency of the nuclear reaction of protons with ^{11}B nuclei to explain the radiosensitizing effects of boron preparations observed in a number of studies when human malignant cells are irradiated with protons at the Bragg peak.

The potential of combined effects of ionizing irradiation and targeting drugs (GANT61 – a small molecule that inhibits the binding of gli transcription factors to DNA) for the therapy of glioblastoma multiforme was also investigated on cellular models. Malignant gliomas are the most aggressive brain tumors that do not respond to standard clinical treatments and lead to rapid patient death. Proton irradiation can eliminate tumor foci discernible on imaging, but “dormant” cancer stem cells can infiltrate the surrounding normal tissue and give rise to new foci, leading to recurrence. Incubation with GANT61 has been shown to induce massive glioma cell death without affecting cell lines lacking gli activity, and significantly increases the sensitivity of cancer cells to γ -radiation or proton irradiation. The results suggest that approaches based on the combined use of the GANT61 inhibitor and proton or γ -radiation irradiation for glioblastoma therapy are promising.

In 2022, the MRBD staff published more than 115 papers in peer-reviewed journals (48 – in foreign journals), made 76 reports at scientific conferences. A new generation of scientists is being trained: 22 postgraduate students studying at the postgraduate program of NRC “Kurchatov Institute” – PNPI and other institutes work in the MRBD, four employees of the Division supervise the work of postgraduate students from other institutions.

Advanced Development Division

Advanced Development Division (ADD), headed by Dr. A.V. Titov, consists of three laboratories:

- Chemistry and Spectroscopy of Carbon Materials (headed by Dr. M.V. Suyasova);
- Holographic Information and Measurement Systems (headed by Dr. B.G. Turukhano);
- Quantum Chemistry (headed by Dr. A.V. Titov)

and three departments:

- Accelerator Department (headed by Dr. E.M. Ivanov), which includes the Laboratory of Physics and Technology of Accelerators (headed by Dr. S.A. Artamonov);
- Applied Nuclear Physics Department (acting head – Dr. K.N. Ermakov), which includes the Laboratory of Radiation Physics (headed by Dr. A.S. Vorobyev);
- Information Technology and Automation Department (headed by S.B. Oleshko), which includes the Laboratory of Information and Computing Systems (headed by S.B. Oleshko).

ADD employs 60 scientists (8 Doctors of Sciences and 29 Candidates of Sciences).



Dr. A.V. Titov,
head of the ADD

The basic accelerator facilities of the Institute are concentrated in the Accelerator Department (AD) of the ADD. First of all, it is a unique synchrotron with an energy

of 1 000 MeV, SC-1000, with a current of 1 μA of the output beam. SC-1000 is used to conduct a wide range of scientific and applied studies in various fields – from nuclear physics to medicine.

Its main distinguishing features are:

- Highly efficient output system (30%), the efficiency of which is five times higher than that of a standard regenerative system;
- The system of time stretching of the derived proton beam, which makes it possible to increase the time filling coefficient of the beam from 2 to 85%.

For a number of physical and applied studies, proton beams of other energies are required. For this purpose, proton beams of variable energy from 60 to 1 000 MeV were created at the SC-1000 of NRC “Kurchatov Institute” – PNPI

by the staff of the AD. The diameter of the obtained beams is $\sim 30\text{--}80$ mm, $\Delta p/p$ is in the range of 1.3–14%, and the intensity varies in the range of $10^7\text{--}10^{12}$ s^{-1} .

In addition to the main proton beam, there is a second one of “low” intensity, about 1% of the main beam, which is extracted from the synchrotron chamber simultaneously with the main beam. The beam can be used for both physical and applied purposes, in particular, for the proton radiation therapy, which can significantly reduce the costs of irradiation of patients.

For scientific research, there are secondary beams of π^\pm and μ^\pm mesons obtained on the external meson-forming target. In the accelerator chamber, neutrons with energies from 0.01 eV to 950 MeV are generated as a result of a single-turn discharge of a proton beam onto an internal neutron-forming lead target.

The improvement of space and aviation technology is largely associated with the use of micro- and nanoelectronics elements. One of the main conditions for their successful use is their long-term robust performance in the radiation fields of outer space and the upper atmosphere. Currently, the regulations of Russia and the standards of the leading countries of the world include mandatory tests of radiation resistance of modern electronic equipment used in aviation and space

technology, relating to the effects of various types of radiation. A specialized center for proton radiation testing with an energy of 60–1000 MeV, including two test benches with beam diagnostic systems, modern dosimetry devices, an automated results processing system and a modern infrastructure for users, became operational at the synchrocyclotron of NRC “Kurchatov Institute” – PNPI in 2015.

The international regulatory document JEDEC STANDARD prescribes testing of electronic components and radio products in neutron fluxes with a spectrum that is similar to that of atmospheric neutrons. In 2015, the Nuclear Fission Physics Group of the NRD and the AD of the ADD completed the creation of such a neutron source at the GNEIS neutron source of the SC-1000 synchrocyclotron.

The high intensity of the neutron beam allows for an accelerated testing of electronics – one hour of exposure of the product on the beam is equivalent to 100 years of stay in flight. Thus, since 2015 the universally valid center for radiation-resistance testing of electronic components has been in operation in NRC “Kurchatov Institute” – PNPI, which now is capable of fully testing the electronics on beams of protons with variable energy and on neutron beams with the range repeating that of atmospheric neutrons.

The AD of the ADD and the Efremov Scientific Research Institute of Electrophysical Apparatus are joining efforts to launch a multipurpose cyclotron complex based on the built isochronous cyclotron C-80 with a variable proton energy of 40–80 MeV and a current of the output beam up to 100 μ A. The high energy of the accelerated beam combined with the high intensity will allow the production of high-quality radioisotopes and radiopharmaceuticals that are not available for commercial cyclotrons, in particular generator isotopes. Generator isotopes open the way for positron emission tomography (PET) in medical centers remote from the cyclotron. The project also provides for the development of a method for creating ultrapure medical isotopes using a magnetic separator. The energy range of the proton beam (60–70 MeV) of the cyclotron C-80 makes it possible to create the only ophthalmological center

in Russia today for proton therapy of oncological diseases of the organs of vision. The AD of the ADD has long been engaged in the development of this project together with the Alikhanov Institute for Theoretical and Experimental Physics of NRC “Kurchatov Institute” (NRC “Kurchatov Institute” – ITEP).

When creating equipment for the ophthalmology room and radiation planning, the vast experience accumulated at NRC “Kurchatov Institute” – ITEP will be used, where about 1400 patients underwent proton therapy sessions until 2010.

The Laboratory of Holographic Information and Measurement Systems (LHIMS) of the ADD is one of the world leaders in the field of precision measurements at the nanometer scale. To carry out these studies, the LHIMS has a modern, unique underground vibration-free holographic laboratory. On the basis of this laboratory and unique test benches for the synthesis of linear and radial holographic diffraction gratings, 14 types of nanotechnological equipment and devices can be produced, including: photovoltaic converters of linear and angular displacements, long meters, two-, three-, four-, and more coordinate measuring machines, radius meters, plane meters, turntables for measuring with the resolution 10 nm and hundredths of a second. In 2015, for the first time in the world, a linear holographic lattice with a length of 1300 mm and a resolution of 1 nm was created in the LHIMS.

For many years, the Department of Information Technology and Automation (DITA) of the ADD has been actively involved in the ATLAS project of the Large Hadron Collider at CERN. Employees of the Laboratory of Information and Computing Systems are engaged in the development and support of various software systems for the detector control system and the data acquisition system of the ATLAS experiment. The Department also supports the local computer network of the Institute, various information and computing systems based on Web technologies, as well as information systems to support the administrative and economic activities of the Institute. The design and technology group of the department participated in the work on the “Proton” program carried out by the HEPD to conduct research on the PS1 muon

beam (CERN) using the IKAR installation. The task of the DITA was to modernize IKAR by creating and embedding segmented anode blocks into the set-up. The work was completed on time, and the upgraded IKAR installation was installed on the beam and passed the necessary beam tests.

Scientists from the Applied Nuclear Physics Department (ANPD) of the ADD participated in four expeditions to Antarctica. Currently, work is underway to prepare for research on the subglacial Lake Vostok. Due to a high degree of pollution, the existing borehole in the subglacial Lake Vostok with a length of 3 769 m cannot be used to study the lake. Because of this, the search for life forms in extreme conditions together with the MRBD is impossible. Scientific research requires the creation of a new well. In this regard, the possibility of drilling a new environmentally friendly borehole in a short time using known drilling methods was analyzed. A method for high-speed drilling with hot silicone fluid was proposed, and the calculation of the drilling process was performed. The development of unique equipment for the study of the subglacial lake continues, options are being considered for expanding the complex of scientific research at “Vostok” station to obtain new information in the field of fundamental scientific knowledge.

At the Laboratory of Radiation Physics of the ANPD, studies of the fission reaction of heavy nuclei are continued on the GNEIS neutron time-of-flight spectrometer created on the basis of the SC-1000. In 2022, the fission cross section and angular distributions of fission fragments of the ^{238}U nucleus were measured during interaction with neutrons with energies from 1 to 200 MeV. For this nucleus, the current accuracy of determining the fission cross section is insufficient and must be increased, as follows from the nuclear power development program based on the implementation of a closed fuel cycle and its systems such as Gen-4 nuclear power plants (NPPs) and the accelerated driven system. Since the accuracy of cross section calculations performed using standard methods and approaches remains insufficient for NPP engineering calculations, obtaining new and reliable nuclear data remains

the only way to reduce the total cross section uncertainty.

The main research trend of the Laboratory of Chemistry and Spectroscopy of Carbon Materials (LCSCM) of the ADD is the development of new fullerene and endometallofullerene derivatives, the study of their physical and chemical properties, radiation resistance and self-assembly in aqueous solutions. One of the most important scientific and practical tasks of the LCSCM is the development of new endometallofullerene derivatives which are promising as systems for targeted drug delivery. Commonly used radiopharmaceuticals contain a radioisotope in combination with a chelating agent that binds the radioactive atom firmly enough and prevents its binding to blood components and other body tissues. However, the stability of such a chelate complex is not absolute and therefore small amounts of toxic radioactive metal can be released into the body. For this purpose, the laboratory studies the radiation resistance of endometallofullerenes and their derivatives under irradiation.

The main direction of the work of the Quantum Chemistry Laboratory (QCL) of the ADD is the development of relativistic methods for calculating the electronic structure of molecules containing heavy atoms. This activity was initiated back in the early 80s of the last century by the need to calculate unusual properties in two-atom molecules with one heavy atom, the knowledge of which is necessary to search for new physics on such molecules beyond the Standard Model. The calculations were based on a two-step method developed in the laboratory, which made it possible to divide the calculation structure of such molecules into two consecutive calculations in the valence region and in the region of the core of a heavy atom. For over 30 years, the accuracy achieved in these calculations has remained the world record. In the last decade, the laboratory staff have not limited themselves to studies of P - and T, P -odd effects, spectroscopic and chemical properties in molecules and clusters of moderate size, they have moved to a wider range of studies into physicochemical properties and more complex structures. The development of methods, algorithms

and software packages for precise simulation of the electronic structure and properties of compounds of heavy elements makes it possible to perform systematic studies of the properties of molecules and materials containing lanthanides, actinides and heavy transition metals, as well as to carry out the most accurate studies of the chemical and spectroscopic properties of compounds of superheavy elements from the “islands of stability”. Annually the QCL publishes more than 25 articles

in leading international and Russian scientific journals.

In 2022, the research staff of the ADD published 42 scientific papers indexed by Web of Science and Scopus, made more than 50 reports at Russian and international scientific conferences and scientific seminars of NRC “Kurchatov Institute” – PNPI, Saint Petersburg University and Lomonosov Moscow State University, and also received nine patents and certificates of invention.

$$T(k) = (k-r)^2 \exp(-\beta k) / (k-r) \exp(-\beta k)$$

$$k_1' = \sqrt{k_1^2 - r^2}$$

$$r = (\sqrt{1+x^2} - x) / (\sqrt{1+x^2} + x)$$

$$|k_1| = \int_{-a}^a |A|^2 dx / 2d$$

$$t \exp(ik_1' l) / [k_1^2 \exp(2ik_1' l)]$$

$$l = 2a + x$$

$$\phi = 2k_1 l$$

$$x = 2k_1 / (k_1 + k_1')$$

$$T = \int T(k) \cos \theta d\theta$$

$$x = 2k_1 / (k_1 + k_1')$$

Theoretical and Mathematical Physics

- 30 Exclusive J/ψ and Y Production
in High Energy pp and pPb Collisions
- 31 The Generalization of the Double-Logarithmic Equation
in the Maximally Extended $N = 4$ Supersymmetric
Yang–Mills Theory
- 32 Neve–Schwartz 3-Form Flux Deformation
for the Critical Non-Abelian Vortex String
- 33 Spin Dynamics of Spin-1/2 Antiferromagnet
on a Triangular Lattice
- 34 Small-Angle Neutron Scattering in the Fully Polarized Phase
of Noncollinear Magnets with Interfacial-Like
Dzyaloshinskii–Moriya Interaction
- 35 Magnon Band Structure of Skyrmion Crystals
and Stereographic Projection Approach
- 36 Progress in the Study of T , P -odd Effects in Molecules
- 37 Combined Method for Calculating the Electronic Structure
of Materials with Lanthanides Based on the Compound-Tunable
Embedding Potential
- 39 Spin-Tautomerism of Endohedral Complexes

Exclusive J/ψ and Y Production in High Energy pp and pPb Collisions

M.G. Ryskin¹, C.A. Flett², S.P. Jones³, A.D. Martin³, T. Teubner⁴

¹ Theoretical Physics Division of NRC “Kurchatov Institute” – PNPI

² University of Jyväskylä, Finland

³ Durham University, the United Kingdom

⁴ University of Liverpool, the United Kingdom

Ultrapерipheral exclusive production of heavy vector mesons at the Large Hadron Collider (LHC) is a very interesting process since it allows measuring the gluon distribution in the proton at very small $x < 0.001$, in the region not reached by other methods.

The cross section of exclusive vector meson photoproduction is proportional to the generalized gluon density square at $x = M_V^2/W_{\gamma p}^2$. This density was extracted by us before from the J/ψ production LHC data at the scale equal to the charm quark mass. The analysis of the heavier Y -meson production will give the gluon density at a larger scale.

The advantage of the proton–lead ion collisions is that in this case the process of ultraperipheral photoproduction can be selected with a better accuracy. However, now one has to account for the possibility of additional interactions of the proton and the vector meson with the nucleons inside the lead nucleus. All these effects were accounted for in the present paper.

The formalism for the calculation of cross sections of exclusive vector meson production in the proton–proton and proton–heavy ion collisions as a function of the vector meson rapidity is described. The formalism accounts for the next-to-leading order quantum chromodynamics corrections and the proton and vector meson rescatterings inside the lead nucleus.

It is shown that the LHC experimental data on J/ψ - and Y -mesons exclusive production will give the possibility to probe the gluon distributions at very small x and different scales. Using the gluon densities obtained by us previously based on the $p + p \rightarrow p + J/\psi + p$ data we predict the cross sections of J/ψ - and Y -mesons production at the LHC energies $\sqrt{s_{pN}} = 5.02$ and 8.16 TeV.

The tables of effective photon fluxes radiated by the proton and the lead ion are presented, where we accounted for the possibility of secondary interactions inside the lead nucleus.

The Generalization of the Double-Logarithmic Equation in the Maximally Extended $N = 4$ Supersymmetric Yang–Mills Theory

V.N. Velizhanin

Theoretical Physics Division of NRC “Kurchatov Institute” – PNPI

The double-logarithmic equation was one of the first evolution equations for the quantities, related to the anomalous dimension of twist-2 operators. Initially, in the leading order, it was obtained in quantum electrodynamics (QED) at the end of the 60s in the theoretical physics department of the Institute. Later, other evolution equations were discovered for the anomalous dimension, structure functions and other quantities, related to high-energy particle scattering at accelerators. The calculations of the corrections to the evolution equations are the actual task both for the phenomenology in the realistic models, such as QED and quantum chromodynamics (QCD), and for the theoretical studies, since they make it possible to obtain the information about the analytical properties of the quantities under consideration.

The double-logarithmic equation appears when considering the processes of scattering of electrons, positrons or quarks at high collision energies, when the calculations within the framework of perturbative theory give the large logarithms in energy, which should be summed in all orders of perturbative theory. Such large logarithms correspond to the poles of the corresponding analytically continued anomalous dimension of twist-2 operators. The direct calculation of corrections to a doubly logarithmic equation is a rather complicated task, and so far, it has not been carried out by generali-

zation of any known methods for its computation in the leading order. However, in the last years the great progress has been made in the computations of the anomalous dimension of twist-2 operators in the maximally-extended $N = 4$ supersymmetric Yang–Mills theory, where the general result is known up to the seventh order of perturbative theory. Using our database for the analytical continuation of the functions, which enter into the general result for the anomalous dimension, we have found a simple way to generalize the double-logarithmic equation, including subleading corrections. The analysis of the obtained equation showed that further simplification is possible if all terms are summed up as a rational function with a simple denominator.

The resulting generalized double-logarithmic equation provides a lot of predictions for the analytically continued anomalous dimension of twist-2 operators in all orders of perturbative theory. Such information can serve both to test the new results for the anomalous dimension of twist-2 operators and to reconstruct the general form of the anomalous dimension from the various available results not only in $N = 4$ supersymmetric Yang–Mills theory, but in realistic QCD, where the generalized double-logarithmic equation is violated in a minor way.

Neve–Schwartz 3-Form Flux Deformation for the Critical Non-Abelian Vortex String

A.V. Yung

Theoretical Physics Division of NRC “Kurchatov Institute” – PNPI

Previously, M. Shifman and A. Yung showed that a solitonic non-Abelian vortex tube (string) supported in $N = 2$ supersymmetric quantum chromodynamics (QCD) with gauge group $U(2)$ and four quark flavors behaves like a critical superstring. Four translational modes combine with six orientational modes to form the ten-dimensional space required for the criticality of the superstring. This opens up the possibility of quantizing such a string and finding its spectrum. The states of a closed superstring that arise in four dimensions are identified with the hadrons of four-dimensional $N = 2$ supersymmetric QCD. Previously, a massless baryon was found which is associated with the modulus of the complex structure of a conifold, a six-dimensional Calabi–Yau manifold on which a non-Abelian string lives.

The purpose of this paper was to introduce nonzero quark masses into four-dimensional QCD and to study their response in the critical superstring theory. In particular, it is of great interest to consider the limit of infinite masses, in which some

quarks decouple. Such a consideration would make it possible to significantly expand the range of four-dimensional $N = 2$ supersymmetric theories, in which the hadronic sector is described by critical superstrings.

The main idea of the paper is that in effective ten-dimensional IIA supergravity describing a string, the effect of introducing quark masses in four-dimensional QCD is reduced to a non-zero flow of the Neve–Schwartz 3-form through a 3-sphere on a conifold. The equations of ten-dimensional gravity are solved and the scalar potential for the modulus of the complex structure of the conifold generated by the 3-form flow is calculated. It turned out that this potential leads to “vacuum runaway to infinity”. In this case, the warp factors of the metric disappear, and the conifold degenerates into a space of lower dimension. In four-dimensional theory, this is interpreted as a deformation of $N = 2$ supersymmetric QCD with $U(2)$ gauge group and four quark flavors into an Abelian theory with two quark flavors.

Spin Dynamics of Spin-1/2 Antiferromagnet on a Triangular Lattice

A.V. Syromyatnikov

Theoretical Physics Division of NRC “Kurchatov Institute” – PNPI

In the modern theory of strongly correlated systems, many collective phenomena are described in terms of elementary excitations (quasiparticles). Therefore, the search for and characterization of quasiparticles is of fundamental importance. Recently, more and more experimental and numerical evidence has appeared that in some (quasi)-two-dimensional collinear and noncollinear quantum magnets, standard analytical methods do not even qualitatively describe short-wavelength spin excitations. One such system is the Heisenberg antiferromagnet with spin 1/2 on a triangular lattice.

The aim of the work was to study the dynamic properties of this model by a new method, especially developed by the author of this work to study the short-wavelength dynamics.

Dynamic spin correlators are analytically calculated using the new method in this model, and the results are compared with the available numerical results, as well as with experimental data obtained in the $\text{Ba}_3\text{CoSb}_2\text{O}_9$ compound, which is well described by this model (Fig.).

A qualitative change in the spectrum of spin waves (elementary excitations known from standard theories) is demonstrated, which cannot be explained within the framework of any of the available analytical approaches, and which is in excellent agreement with the experiment. In addition, new short-wavelength quasiparticles have been discovered, which have never been discussed before, and which give noticeable anomalies in the dynamic spin correlator, observed experimentally and numerically.

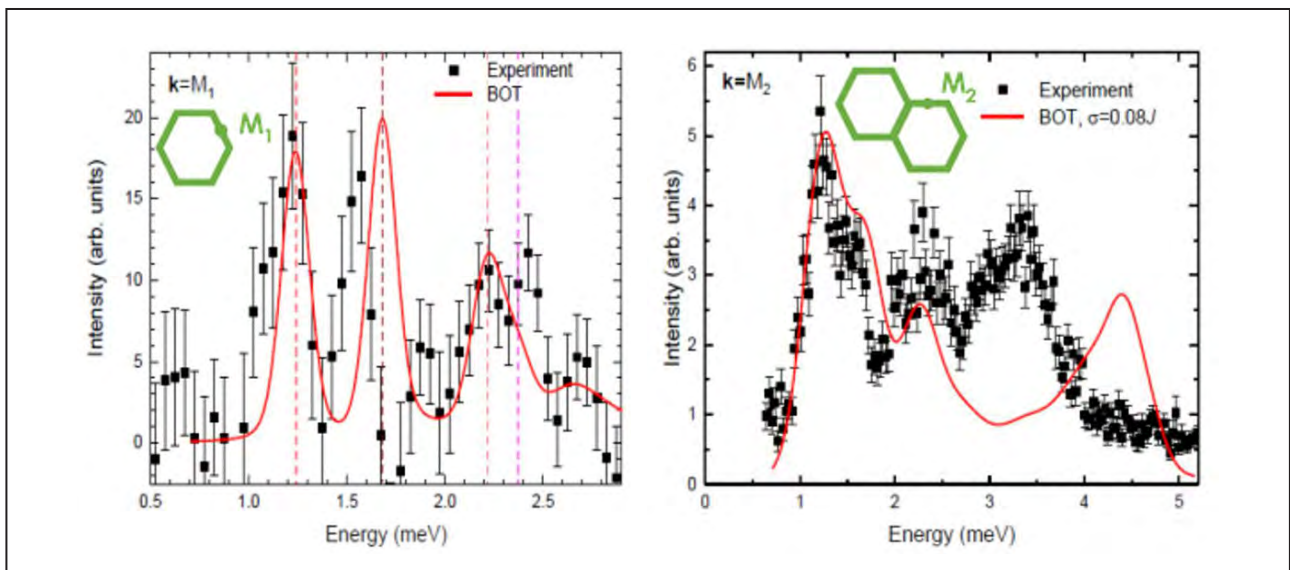

Neutron data obtained in $\text{Ba}_3\text{CoSb}_2\text{O}_9$ at M points at the Brillouin zone boundary. Our proposed approach (BOT) well describes these experiments (red line): we can consider that the agreement is quantitative at $\omega < 2.4$ meV and qualitative at larger ω

Small-Angle Neutron Scattering in the Fully Polarized Phase of Noncollinear Magnets with Interfacial-Like Dzyaloshinskii–Moriya Interaction

O.I. Utesov

Theoretical Physics Division of NRC “Kurchatov Institute” – PNPI

The present research is devoted to a theoretical study of peculiarities of small-angle neutron scattering in the fully polarized phase of noncollinear magnets with interfacial-like Dzyaloshinskii–Moriya interaction for the purpose of their further experimental characterization by this method.

Noncollinear magnets are considered as promising materials for creating new devices, in particular, memory schemes. However, for their direct use, one should know the parameters that are present in models for a description of these compounds. In the present study, the small-angle neutron scattering method is proposed for their experimental determination.

Using the bosonic representation of the spin operators in the fully polarized phase of noncollinear magnets with interfacial-like Dzyaloshinskii–Moriya interaction, equations for the magnon spectrum were obtained for the external magnetic field orientation along the high-symmetry axis (z-axis) and perpendicular to it (in the xy plane). Moreover, the influence of the single-ion anisotropy was taken into account. It was shown that in the case of the perpendicular to high-symmetry axis field, the magnon is nonreciprocal, i. e. shifted from zero by the cycloid modulation vector.

Utilizing known equations for the neutron scattering cross-section, obtained magnon spectra allow us to analyze the so-called neutron scattering maps, which can be experimentally obtained in compounds of the considered type.

Four possible experimental geometries were proposed and analyzed. For each of them, the ana-

lytical expression for the cut-off curve on the scattering map was obtained as a function of parameters of the mathematical model describing the system (Fig.).

Importantly, the cut-off curve can be not only a circle, as in cubic helimagnets, but an ellipse. Moreover, its center can coincide with the coordinates origin or it can be shifted by the cycloid modulation vector depending on the field orientation.

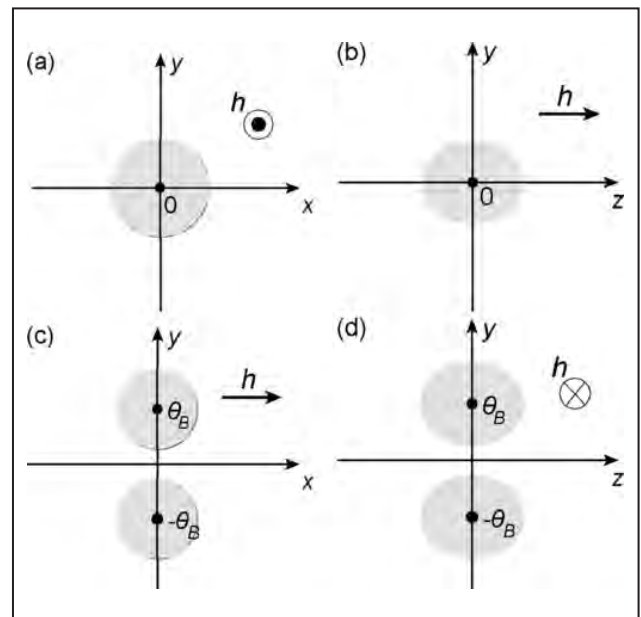

Small-angle neutron scattering maps for various orientations of the external field: a – the field is along the high-symmetry z-axis, the detector is in the xy plane; b – the field along the z-axis, the detector in the yz plane; c – the field in the detector plane yz; d – the field along the x-axis, the detector plane is yz

Magnon Band Structure of Skyrmion Crystals and Stereographic Projection Approach

V.E. Timofeev, D.N. Aristov

Theoretical Physics Division of NRC “Kurchatov Institute” – PNPI

Skyrmion lattices were experimentally discovered more than a decade ago. Skyrmions are magnetic knots of the size of tens of nanometers, and these topological structures are of great interest, because they could be used as building blocks of novel fast and capacious random access memory devices. Besides their practical usage, there is a great academic interest in theoretical studies of skyrmion lattices. Previously we proposed a stereographic projection approach as a method of analysis of multiskyrmion configurations. This approach allows one to rewrite components of local magnetization in terms of a complex-valued function, with centers of skyrmions corresponding to the singularities of this function.

We consider infinitesimal time-dependent fluctuations around the optimal stereographic function, and obtain equation of motion for magnons (elementary excitations of local magnetization). The structure of this equation is similar to the Bogoliubov–de Gennes equation. The developed method was applied to the well-known model of a two-dimensional ferromagnet with Dzyaloshinskii–Moriya interaction in external magnetic field. There is a wide region of parameters in this model where hexagonal lattice of Bloch type skyrmions is a ground state of the system. We calculate the dispersion of low-lying excitations (Fig.), their wave functions, Berry curvature and topological indexes of correspondent bands. The magnetic field dependence of all these characteristics is also studied. The results of our study can be

further applied for calculation of observable characteristics of multiskyrmion configurations and for prediction of their behavior.

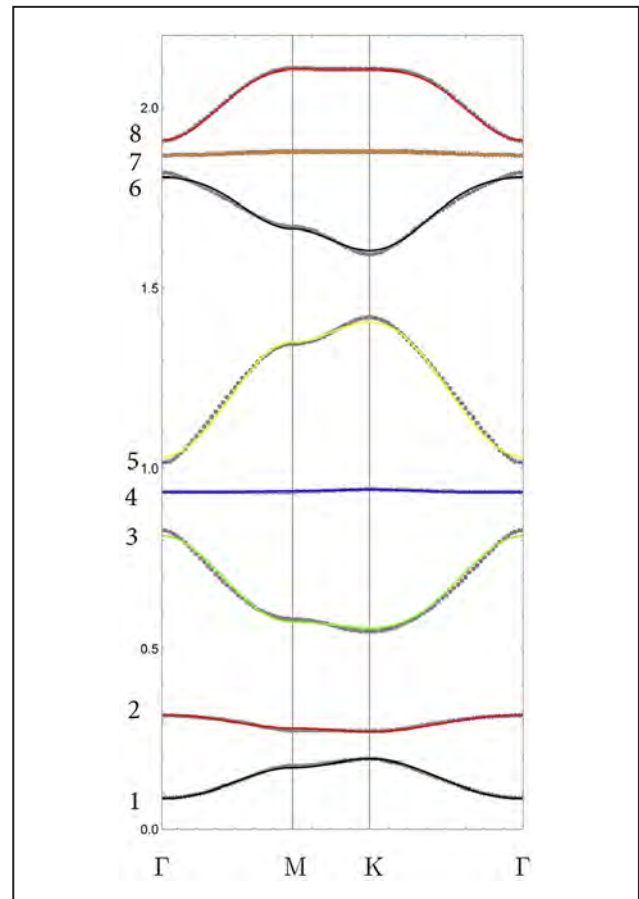

Magnon spectrum in the hexagonal Brillouin zone. The abscissa axis shows the sweep along the lines connecting the symmetric points of the Brillouin zone – Γ , M, K. The energy on the ordinate axis is given in units of D^2/J

Progress in the Study of T, P -odd Effects in Molecules

A.N. Petrov, L.V. Skripnikov, A.V. Zakharova, I.P. Kurchavov,
D.E. Maison, G.O. Penyazkov, A.V. Titov

Advanced Development Division of NRC “Kurchatov Institute” – PNPI

The energy difference due to the T, P -odd (T – time reversal, P – space inversion) interactions of levels with opposite projections of the angular momentum (M) of the molecule on the direction of the external electric field is $E_M - E_{-M} = P_e(d_e E_{\text{eff}} + k_s E_s)$, where P_e – degree of polarization (T, P -odd) of the molecule; d_e – electric dipole moment of electron (eEDM); k_s – coupling constant for the scalar–pseudoscalar electron–nuclear interaction. Knowing the parameters P_e , E_{eff} and E_s (can be only calculated), one can extract the values d_e and k_s from the measured splitting $E_M - E_{-M}$. A non-zero result at the current level of accuracy will be a direct evidence of new physics beyond the Standard Model. Since 2017 it was believed that P_e for triatomic molecules reaches unity already for small electric fields. We have shown that this is not the case and developed a method for evaluating P_e , which was demonstrated using YbOH as an example. Our calculations make it possible to correctly interpret experiments on triatomic molecules. Then the method was applied to the LuOH⁺ cation and developed to calculate the sensitivity of triatomic molecules to the magnetic quadrupole moment of nucleus.

Experiments on triatomic molecules are planned as the next studies, more accurate than those on the diatomic molecules, on which the experiments are successfully continuing. Recently, a new limit for eEDM $d_e < 4 \cdot 10^{-30} e \cdot \text{cm}$ has been obtained on the HfF⁺ cation. In addition to measuring the eEDM, other quantities are also measured with high accuracy, for example, the frequencies f^0 и f^D , which are

the average value and the difference in splittings of Ω -doublets in external rotating electric and magnetic fields. Their justification from the first principles is very important both for the development of modern molecular theory and for understanding possible systematic errors in experiments. The results of our calculations, which consider many perturbations in the spectrum of the molecule (*black curve* in the Fig.), reproduce perfectly the experimental data (*black circles* in the Fig.), which were provided to us by L. Caldwell, T. Wright, J. Ye, and E. Cornell. Similar accuracy in comparison with the experiment was achieved for other combinations of splittings of Ω -doublets. Our calculations made it possible to significantly refine the value of the molecular dipole moment of HfF⁺ and explain the discrepancies between the calculated and experimental times for the $\pi/2$ pulse.

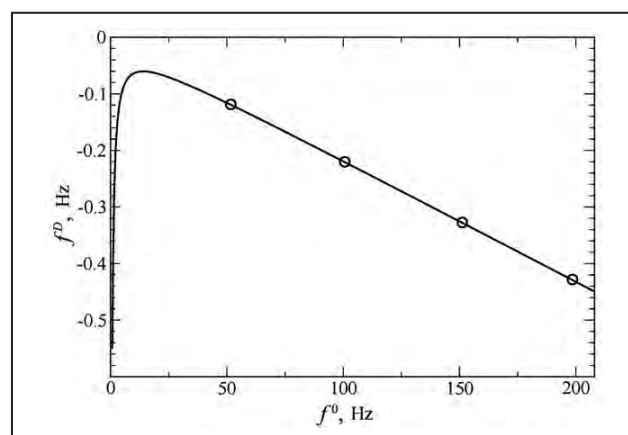

Calculated (*curve*) and experimental (*circles*) frequency f^D as a function of frequency f^0

1. Petrov A., Zakharova A. // Phys. Rev. A. 2022. V. 105. P. L050801.
2. Maison D.E., Skripnikov L.V., Penyazkov G.O., ..., Petrov A.N. // Phys. Rev. A. 2022. V. 106. P. 062827.
3. Kurchavov I., Petrov A. // Phys. Rev. A. 2022. V. 106. P. 062806.
4. Petrov A.N., Skripnikov L.V., Titov A.V. <https://arxiv.org/abs/2302.02856>

Combined Method for Calculating the Electronic Structure of Materials with Lanthanides Based on the Compound-Tunable Embedding Potential

V.M. Shakhova, D.A. Maltsev, Yu.V. Lomachuk, N.S. Mosyagin, L.V. Skripnikov, A.V. Titov

Advanced Development Division of NRC “Kurchatov Institute” – PNPI

In Quantum Chemistry Laboratory of NRC “Kurchatov Institute” – PNPI the combined method for modeling the electronic structure of materials using compound-tunable pseudopotentials (CTPP) and compound-tunable embedding potential (CTEP) has been developed.

The construction of a CTEP for a given crystal fragment is carried out in three stages. At the first stage, a perfect crystal with periodic boundary conditions is calculated by the CRYSTAL code. At the second stage, short-range large-core CTPP is built for the chosen crystal by using the CRYSTAL code as well. At the third stage, cluster calculations of the crystal fragment are performed, and the long-range Coulomb potential of the environment is constructed as a part of CTEP. A crystal fragment of a “required minimal size” (the minimal cluster includes a heavy atom and its immediate environment) is cut out, within which the electron density must be reproduced with high accuracy. The atoms of the near environment of the crystal fragment are described by point charges and CTPPs (“pseudoatoms”) to consider the influence on a chosen fragment of the “whole crystal” excluding the atoms of the fragment. It is important to note that relaxation of the crystal fragment environment is considered as negligible by appropriate choosing the fragment, and the whole system is generally electroneutral taking into account the pseudoatoms of the near environment.

Using the combined method, crystals with an ionic-covalent bond type and a lanthanide atom in a periodic structure (YbF_2 , YbF_3 , YbCl_2 , YbCl_3) were studied and the following key results were obtained.

1. In the framework of periodic calculations, the use of precision pseudopotentials (small-core PP)

for heavy atoms and saturated basis sets for all atoms is practically impossible, less precise pseudopotentials and “trimmed” basis sets are used instead. Consequently, the accuracy of the calculations at this stage is at the level of 0.1 eV for the energy characteristics. It is important to note that for *f*-elements the typical electron excitation energy is about 0.1 eV. It follows that the method of studying materials with *f*-elements as ideal crystals with periodic boundary conditions does not allow obtaining accurate results, so it is necessary to use another approach.

2. The crystal fragment built by the CTEP method using CTPP reproduces the electron density from periodic calculations in the vicinity of the Yb atom with very high accuracy (Fig.), i. e., practically does not introduce additional errors, except for those already present in the calculations of the periodic structure taken as a basis for building the model.

3. In the framework of periodic calculations, the use of precise small-core pseudopotentials and saturated basis sets is practically impossible. Consequently, the accuracy of such calculations is at the level of 0.1 eV for the energetic characteristics. In turn, such a problem does not arise in cluster CTEP calculations, since both good basis sets and pseudopotentials are used, and the calculation errors associated with them are drastically reduced. This was shown in the framework of the analysis of the structural parameters of crystals and corresponding clusters. Already in our pilot calculations, an improvement of two to three times was achieved for those parameters that were the worst reproduced in calculations with CRYSTAL code.

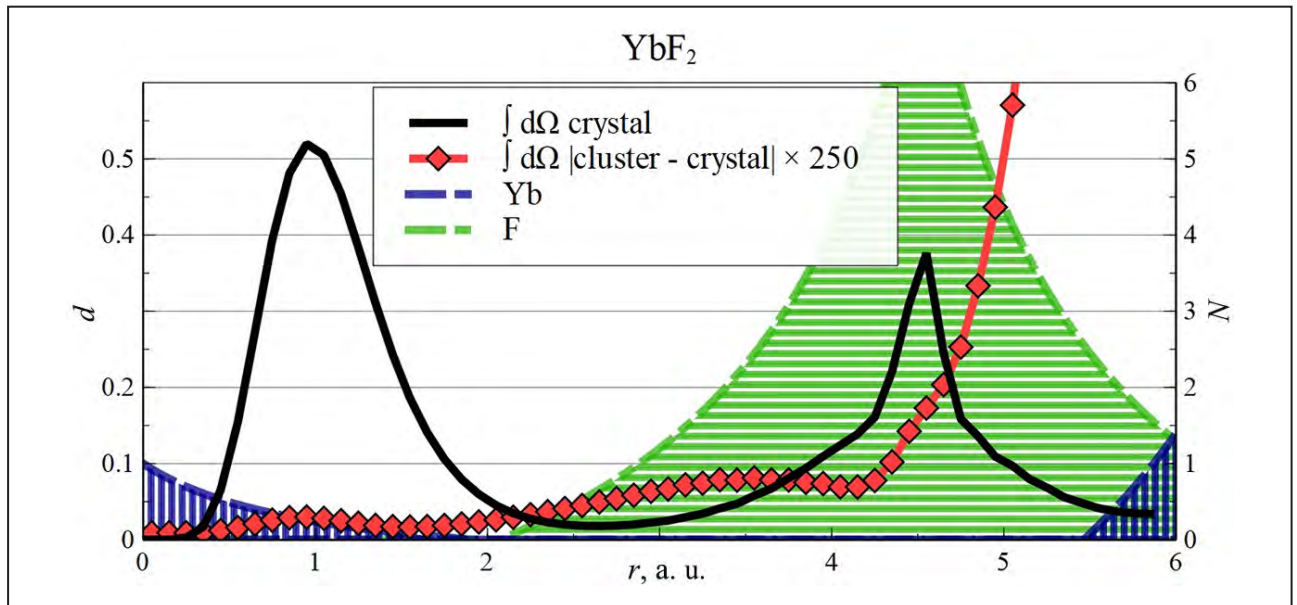

The radial dependence of spherically-averaged absolute differences of electronic densities for the YbF_2 crystal (black line) and corresponding cluster (red line) centered on the ytterbium atom. Filled dashed peaks at the bottom qualitatively represent the position of the neighbour atoms in the crystal fragment

Spin-Tautomerism of Endohedral Complexes

S.G. Semenov¹, M.E. Bedrina², T.A. Andreeva², A.V. Titov^{1,2}

¹ Advanced Development Division of NRC “Kurchatov Institute” – PNPI

² Saint Petersburg University

Using Eu@C₆₀ as a case study, we have investigated endohedral spin tautomerism – a fast reversible change in the equilibrium position of a particle inside a cavity, accompanied by a change in the spin and vibrational spectrum of the endohedral complex.

The structural parameters and vibrational frequencies of the complex at the minimum and saddle points of the interaction potential of an endoatom with fullerene were determined by the (U)PBE0/SDD method. The set of local minima correspond to nonequivalent quasidegenerate endoisomers I and II. In the equilibrium structure of isomer I, the lanthanide nucleus is located under the center of the C=C bond, and the η²-coordination of the endoatom with two neighboring fullerene atoms in the singlet spin state occurs. In the equilibrium structure of isomer II, it is located under the hexagonal face, and η⁶-coordination with the cyclohexa-1,3,5-triene fullerene fragment in the triplet spin state is carried out. The europium endoatom retains seven unpaired electrons in the 4*f*-shell. The degree of degeneracy of isomer I

coincides with its spin multiplicity (7 + 1 = 8); the degree of quasidegeneracy of isomer II is equal to the product of the spin multiplicities of the fullerene and the 4*f*-shell (3 · 8 = 24). The calculated IR spectra of the isomers differ significantly.

Energy barriers corresponding to saddle points between minima are very small. They do not prevent the movement of the endoatom along the classical trajectories under the twenty hexagonal faces of the fullerene polyhedron, bypassing the twelve pentagonal faces. Isomers I and II differ in the number of unpaired electrons (7 and 9) and in the vibrational spectrum, but they have practically the same binding energies of the endoatom with the fullerene $E_b \approx 2.25$ eV and close equilibrium distances between the europium nucleus and the nuclei of neighboring carbon atoms: 256 pm in the isomer I and 265 pm in isomer II.

The non-preservation of spin by a complex containing a heavy endoatom of a lanthanide (Eu, Yb, etc.) allows us to consider the η²- and η⁶-isomers I and II as endohedral spin-tautomers affected by a magnetic field.

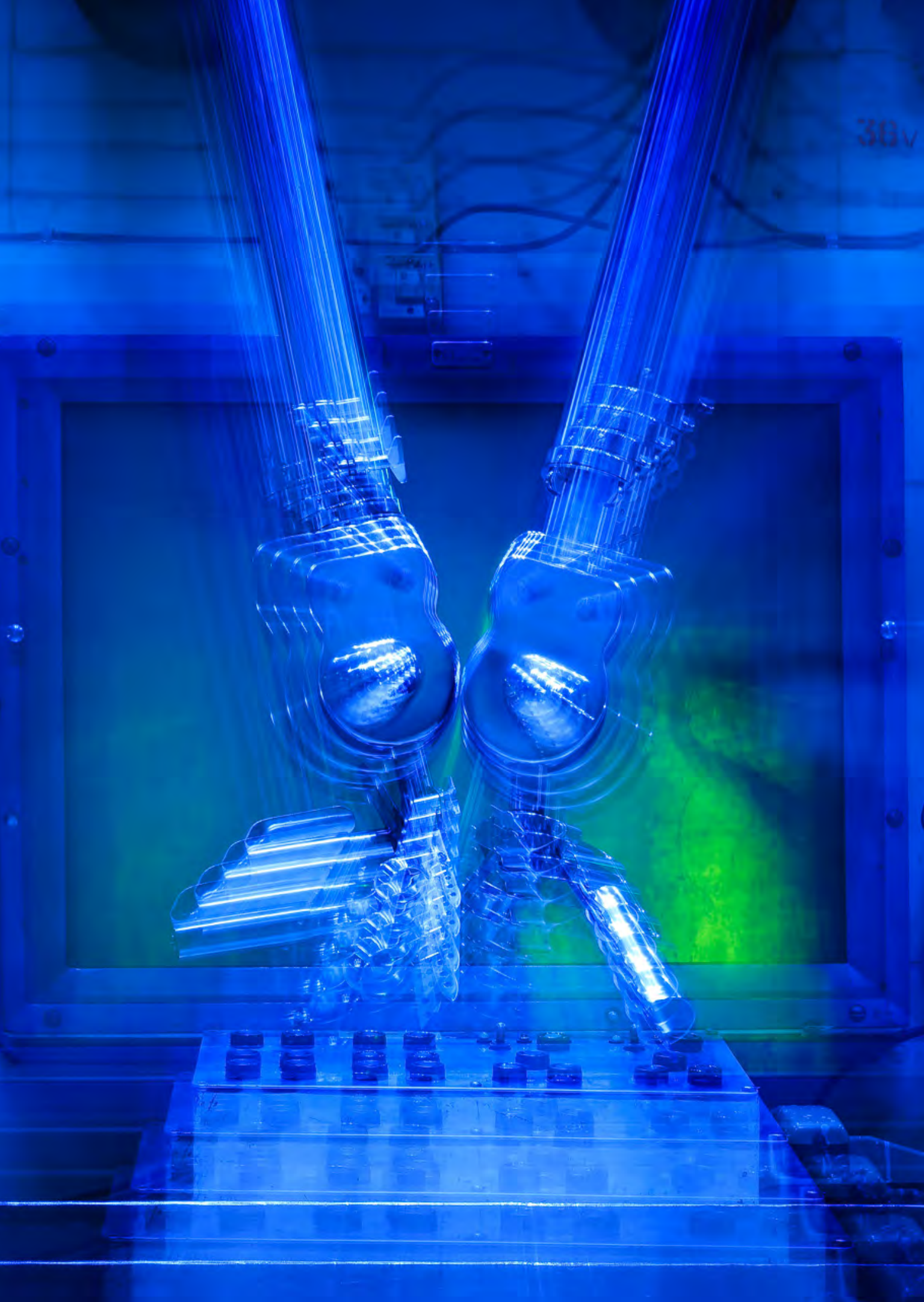

Research Based on the Use of Neutrons, Photons, and Muons

- 42 Commensurate Helicoidal Order in Triangular Layered Magnet $\text{Na}_2\text{MnTeO}_6$
- 43 The Influence of Magnetic Impurities on Superconductivity in LaH_{10}
- 44 The Balance of Weak Interactions Determines the Magnetic Phase Diagram of Orthoferrites $R\text{FeO}_3$
- 45 Experimental Evidence for Logarithmic Fractal Structure of Botanical Trees

Commensurate Helicoidal Order in Triangular Layered Magnet $\text{Na}_2\text{MnTeO}_6$

A.I. Kurbakov, A.E. Susloparova

Neutron Research Division of NRC “Kurchatov Institute” – PNPI

Low-dimensional magnetic systems are quite sensitive to tiny variations of exchange interaction parameters responsible for the formation of either liquid or long-range ordered magnetic ground states. Similarly susceptible they are to the effects of single-ion anisotropy following qualitatively different protocols in Heisenberg-type and Ising-type cases. Triangular magnetic systems are subject to magnetic frustration stemming from the competition of mutually exclusive couplings. The family of trigonal layered quaternary tellurates $A_2\text{MnTeO}_6$ (A is monovalent metal) provides a unique possibility to tune the interlayer exchange interaction parameters, leaving the parameters of magnetic exchange in the layers virtually intact. The ions of tetravalent manganese with spin $S = 3/2$ in $A_2\text{MnTeO}_6$ (sp. gr. $P-31c$) form a diluted triangular net within the layer being separated by the hexavalent tellurium ions (Fig. 1.). Herein, the arrangement of both Mn^{4+}O_6 and Te^{6+}O_6 centered edge-sharing octahedra is of the honeycomb type.

The compound $\text{Na}_2\text{MnTeO}_6$ experiences an antiferromagnetic order at $T_N = 5.5$ K preceded by

short-range correlations well above the ordering temperature. We have found that the solution for the magnetic structure corresponds to the magnetic Shubnikov group $R-3'c'$. Mn^{4+} ions in an octahedral environment form a triangular network where all spins are directed from the center of each triangle. The overall magnetic structure in $\text{Na}_2\text{MnTeO}_6$ is a commensurate 120° spin helix with propagation vector $\mathbf{k} = (1/3, 1/3, 1/3)$ (Fig. 2) in variance with the planar spin structure in structurally equivalent $\text{Li}_2\text{MnTeO}_6$ with magnetic propagation vector $\mathbf{k} = (1/3, 1/3, 0)$.

Thus, a comparative study of $\text{Na}_2\text{MnTeO}_6$ and $\text{Li}_2\text{MnTeO}_6$ has revealed an important aspect of the effect of interlayer coupling on magnetism in layered quasi-two-dimensional magnets with frustrated interaction within the layers, in case when magnetic ions form a triangular AFM structure. Evidently, the slight variations in interlayer exchange interactions lead to a qualitative change in the ground magnetic state resulting in different spin orders.

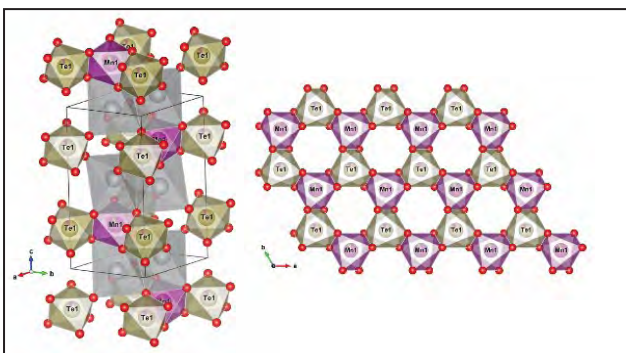

Fig. 1. Layered crystal structures of $\text{Na}_2\text{MnTeO}_6$ (left panel). The projection of the magnetic layer $(\text{MnTeO}_6)_2^{2-}$ on the ab plane, in which the MnO_6 and TeO_6 octahedra alternate sharing their edges (right panel)

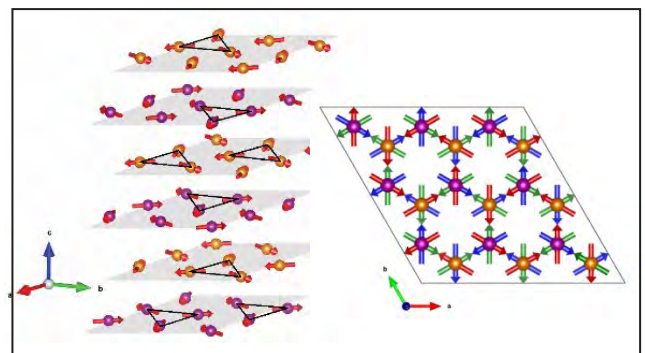

Fig. 2. Spin structure of $\text{Na}_2\text{MnTeO}_6$ compound. Left panel – spin triangles are marked by solid lines. Right panel – projection of the magnetic structure onto the ab plane; the three ordering layers are marked with different arrow colors; ions at neighboring levels along the z -coordinate and varying in the direction of spin are shown in different colors as well

The Influence of Magnetic Impurities on Superconductivity in LaH_{10}

A.A. Bykov¹, K.Yu. Terent'ev¹, D.V. Semenov², D. Zhou², M. Galasso², A.G. Kvashnin², A.R. Oganov², I.A. Troyan³, A.G. Ivanova³, A.Yu. Seregin³, I.S. Lyubutin³, A.V. Sadakov⁴, O.A. Sobolevskiy⁴, K.S. Pervakov⁴, V.M. Pudalov⁴, I.A. Kruglov⁵, A.V. Cherepakhin⁶

¹ Neutron Research Division of NRC "Kurchatov Institute" – PNPI

² Skolkovo Institute of Science and Technology

³ Shubnikov Institute of Crystallography of RAS

⁴ Lebedev Physical Institute of RAS

⁵ Federal State Unitary Enterprise Dukhov Automatics Research Institute

⁶ Kirensky Institute of Physics of the SB of RAS

Polyhydrides are a novel class of superconducting materials with extremely high critical parameters, which is very promising for sensor applications. On the other hand, a complete experimental study of the best so far known superconductor, lanthanum superhydride LaH_{10} , encounters a serious complication because of the large upper critical magnetic field $H_{c2}(0)$, exceeding 120–160 T. It is found that partial replacement of La atoms by magnetic Nd atoms results in significant suppression of superconductivity in LaH_{10} : each at. % of Nd causes a decrease in T_c by 10–11 K, helping to control the critical parameters of this compound. Strong pulsed magnetic fields up to 68 T are used

to study the Hall effect, magnetoresistance (*right figure*), and the magnetic phase diagram (*left figure*) of ternary metal polyhydrides for the first time. Surprisingly, $(\text{LaNd})\text{H}_{10}$ demonstrates completely linear $H_{c2}(T) \sim |T - T_c|$, which calls into question the applicability of the Werthamer–Helfand–Hohenberg model for polyhydrides. The suppression of superconductivity in LaH_{10} by magnetic Nd atoms and the robustness of T_c with respect to nonmagnetic impurities (e. g., Y, Al, C) under Anderson's theorem gives new experimental evidence of the isotropic (s-wave) character of conventional electron–phonon pairing in lanthanum decahydride.

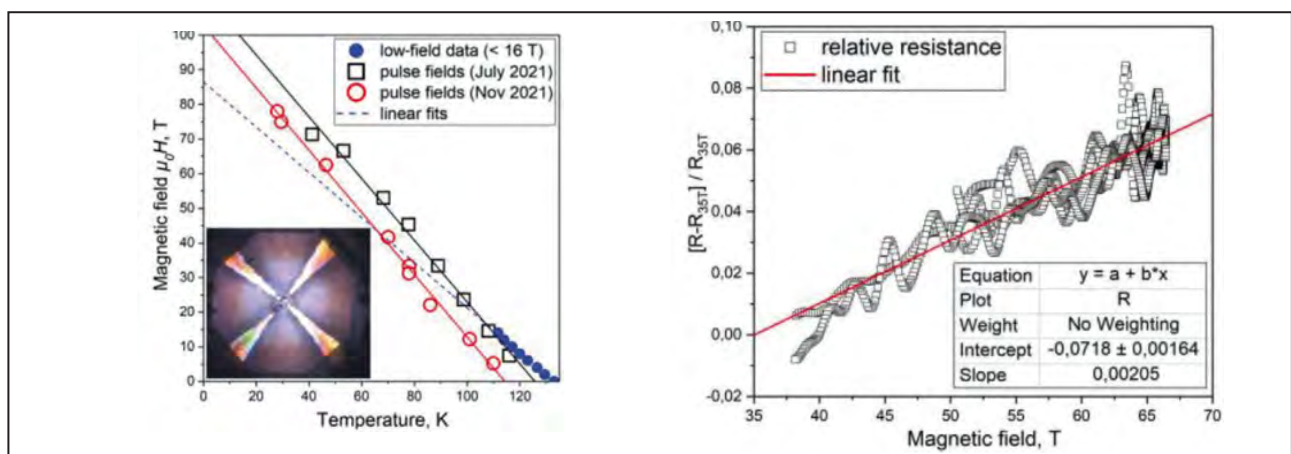

H - T phase diagram $(\text{La}_{0.91}\text{Nd}_{0.09})\text{H}_{10}$ (on the left). The linear nature of the magneto – resistance in pulsed magnetic fields 37–67 T at 105 K (on the right). On the insert – a photograph of the sample in the diamond anvil at 170 GPa. Poped electrical contacts are visible

Semenok D.V., Troyan I.A., Sadakov A.V., Zhou D., Galasso M., Kvashnin A.G., Ivanova A.G., Kruglov I.A., Bykov A.A., Terent'ev K.Yu., Cherepakhin A.V., Sobolevskiy O.A., Pervakov K.S., Seregin A.Yu., ..., Pudalov V.M., Lyubutin I.S., Oganov A.R. // Adv. Mater. 2022. V. 34. Publ. No. 2204038.

The Balance of Weak Interactions Determines the Magnetic Phase Diagram of Orthoferrites $R\text{FeO}_3$

I.A. Zobkalo, A.K. Ovsyanikov, K.Yu. Terent'ev, O.V. Usmanov

Neutron Research Division of NRC "Kurchatov Institute" – PNPI

By the use of inelastic neutron scattering, as well as neutron diffraction in external magnetic fields, magnetic interactions in multiferroic orthoferrites $R\text{FeO}_3$ ($R = \text{Ho}, \text{Tb}, \text{Yb}$) were studied.

The measured temperature evolution of the energy gap in the magnon spectrum of $R\text{FeO}_3$ ($R = \text{Ho}, \text{Tb}, \text{Yb}$) made it possible to obtain the temperature dependence of magnetic anisotropy. In the case when the magnetic moments of iron have a predominant direction along the c axis (Γ_4 phase), the anisotropy is of the "easy plane" type, while in the Γ_2 phase, when the iron spins are oriented along the b axis mainly, the anisotropy of the "easy axis" type dominates.

It is shown that there is a significant difference between the exchange energy in the ab plane and along c , which was not previously taken into account: for HoFeO_3 $J_{ab}^{\text{Fe-Fe}} = 4.764(5)$ meV, $J_c^{\text{Fe-Fe}} = 4.901(5)$ meV, for TbFeO_3 $J_{ab}^{\text{Fe-Fe}} = 4.55(2)$ meV,

$J_c^{\text{Fe-Fe}} = 4.77(1)$ meV. The parameters of exchange interactions between iron ions for the next nearest neighbors were also obtained: $J_{nnn}^{\text{Fe-Fe}} = 0.10(2) - 0.15(1)$ meV, between the iron and rare-earth sublattices $J^{(\text{Fe-R})} \sim -0.026(2)$ meV, as well as exchange parameters within the rare-earth sublattice $J^{(\text{R-R})} \sim 0.035(5)$ meV; and antisymmetric exchange parameters $D1 = 0.12(2) - 0.13(3)$ meV, $D2 = 0.08(2) - 0.10(3)$ meV. Our research shows that $R\text{FeO}_3$ have a rich phase diagram in an external magnetic field (see Fig.). The exchange within the Fe subsystem is the strongest and plays a major role throughout the entire temperature range below T_N . However, less strong interactions significantly affect the magnetic structure. As a result of the fine balance between these weak interactions, one or another sequence of orientation transitions is realized.

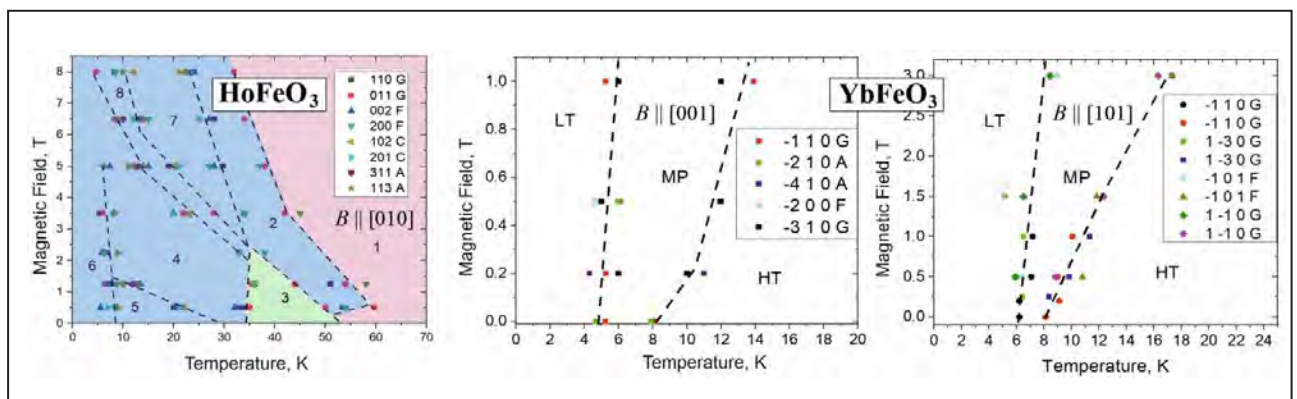

Magnetic phase diagrams of HoFeO_3 , YbFeO_3

1. Ovsyanikov A.K., Usmanov O.V., Zobkalo I.A., ..., Terentjev K.Yu. et al. // J. Magn. Magn. Mater. 2022. V. 557. P. 169431.
2. Ovsyanikov A.K., Usmanov O.V., Zobkalo I.A., ..., Terentjev K.Yu. et al. // J. Magn. Magn. Mater. 2022. V. 563. P. 170025.

Experimental Evidence for Logarithmic Fractal Structure of Botanical Trees

S.V. Grigoriev, O.D. Shnyrkov, P.M. Pustovoit, E.G. Iashina, K.A. Pshenichnyi

Neutron Research Division of NRC “Kurchatov Institute” – PNPI

Many centuries ago, Leonardo da Vinci formulated the law of tree growth as the rule of “conservation of area”. According to this rule, the cross-sectional area of branches below a given branch point is equal to the sum of the cross-sectional areas of child branches above this branch point: $d_i^2 = n \cdot d_{i+1}^2$, where d is the diameter of the branch and n is the number of branches.

This law can be reformulated in terms of a very specific fractal structure – the logarithmic fractal. We used numerical Fourier analysis to identify the logarithmic fractal properties of two-dimensional objects, and then applied it to study the branching system of real three-dimensional trees through their projection onto two-dimensional space, that is, through their photographs. For different types of trees, we observe a q^{-2} decay of the spectral intensity, which characterizes the branching structure and is determined by the logarithmic fractal structure in two-dimensional space (Fig.).

Studies of projections of various types and various individuals of trees have shown that it is necessary to either replace or supplement Leonardo’s rule of conservation of area with a new rule applied to the product of the diameter d and the length l of branches: $d_i \cdot l_i = n \cdot d_{i+1} \cdot l_{i+1}$. We have to admit that Leonardo’s rule applies only if the length of the branch of the next generation is \sqrt{n} times less than that of the previous one, that is, under the condition $l_i = \sqrt{n} \cdot l_{i+1}$. If both rules are satisfied,

one can formulate a law for the volume for different generations of tree branches: the volume (mass) of all branches of the next generation is d_i/d_{i+1} times less than that of the previous generation.

In other words: the tree itself in three-dimensional space is not a logarithmic fractal, while its projections, both from above and from the side, have the structure of a logarithmic fractal. We can conclude that the life of a tree flows according to the laws of two-dimensional space.

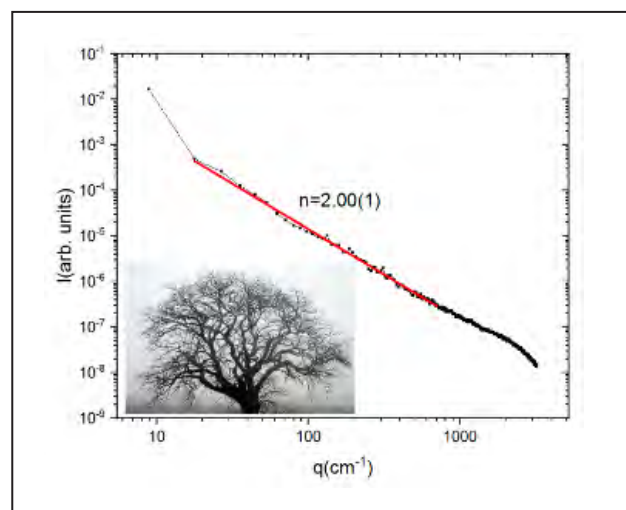

The result of studying a photograph of an oak tree using the Fourier analysis method. The curve of spectral intensity depending on the inverse coordinate q has a section with a slope close to 2, which corresponds to a logarithmic fractal structure



Research Based on the Use of Protons and Ions. Neutrino Physics

- 48 Search for a Higgs-Boson Decay to the Dark Matter Particles Using 139 fb^{-1} of Proton-Proton Data Recorded by the ATLAS Experiment
- 49 Measurement of the Z Boson Production Cross Section in pp Interactions at $\sqrt{s} = 13 \text{ TeV}$
- 50 Indications of BFKL Effect Manifestation in the CMS Experiment for the Dijet Events with Large Rapidity Intervals in pp Collisions at 2.76 TeV Energy
- 51 Observation of Single-Top-Quark Production in Association with a Photon at the ATLAS Detector
- 52 Feasibility Study of τ -Lepton Anomalous Magnetic Moment Measurements with Ultraperipheral Collisions
- 54 First Observation of a Shape Isomer and a Low-Lying Strongly-Coupled Prolate Band in Semimagic ^{187}Pb
- 55 Direct High-Precision Mass Spectrometry of Superheavy Elements with SHIPTRAP
- 56 Study of the Structure of Light Exotic Nuclei by Proton Elastic Scattering in Inverse Kinematics Using the Active Target IKAR
- 58 Prospects for the Study of Extreme States of Nuclear Matter in MPD Experiment at NICA Accelerator
- 60 Nonequilibrium Hydrodynamic Approach to Describing the Emission of High-Energy Secondary Particles in Intermediate-Energy Heavy-Ion Collisions
- 61 First Measurement of Solar Neutrino Directionality with Energies Below 1 MeV by the Borexino Detector
- 62 A New Limit on Axion-Electron Coupling Constant for Solar Axions
- 63 A Search for Low-Energy Signals Associated with Fast Radio Bursts in the Borexino Detector

Search for a Higgs-Boson Decay to the Dark Matter Particles Using 139 fb^{-1} of Proton–Proton Data Recorded by the ATLAS Experiment

S.G. Barsov, V.T. Grachev, A.E. Ezhilov, M.P. Levchenko, V.P. Maleev, Yu.G. Naryshkin, D. Pudzha, V.M. Solovyev, O.L. Fedin, G.V. Fedotov, V.A. Schegelsky

High Energy Physics Division of NRC “Kurchatov Institute” – PNPI,
ATLAS Collaboration

Searches for a new physics beyond the Standard Model (SM), especially dark matter (DM) particles, is one of the main goals of the ATLAS experiment at the Large Hadron Collider (LHC). According to the Higgs portal model the Higgs boson might decay into a pair of weakly interacting massive particles (WIMPs).

The search of the invisible Higgs boson decay has been performed in the ATLAS experiment based on the 13 TeV proton–proton collision data collected in LHC Run 2 (2015–2018) with the luminosity 139 fb^{-1} . DM particles could not interact directly with the ATLAS detector and would only be inferred through momentum conservation in the collision. A necessary signature of such events is the presence of a large missing transverse energy, which is determined from the sum of the transverse components of the momenta of registered particles. In this study selected events were required exactly two oppositely charged electrons or muons with an invariant mass consistent with the mass of the Z boson and missing transverse momentum $E_T^{\text{miss}} > 90 \text{ GeV}$. The data is found to be in good agreement with the SM expectation. The observed upper limit on the branching ratio of Higgs boson decay to the invisible particles is

found to be 19%. Figure shows the comparison of spin independent WIMP-nucleon scattering cross section obtained in the ATLAS experiment and in direct-detection experiments. The limits obtained in this analysis are particularly competitive for low DM masses $m_{\text{WIMP}} < 10 \text{ GeV}$ for the spin-independent WIMP-nucleon interaction, where experiments relying on recoil measurements have limited sensitivity.

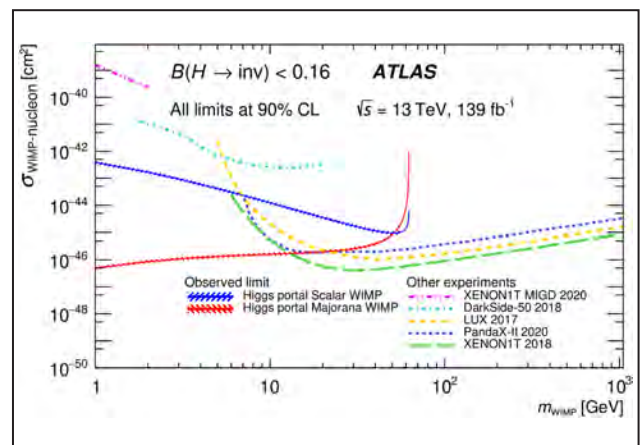

Comparison between upper limits on the spin-independent WIMP-nucleon scattering cross-section from direct-detection experiments and in the ATLAS experiment, as a function of the WIMP mass

Measurement of the Z Boson Production Cross Section in pp Interactions at $\sqrt{s} = 13$ TeV

G.D. Alkhazov, A.V. Andreianov, N.F. Bondar, A.D. Chubykin, V.V. Chulikov, A.A. Dzyuba, D.S. Ilin, A.G. Inglessi, K.A. Ivshin, S.N. Kotriakhova, P.V. Kravchenko, O.E. Maev, D.A. Maisuzenko, N.R. Sagidova, A.N. Solovev, I.N. Solovyev, **A.A. Vorobyev**, N.I. Voropaev

High Energy Physics Division of NRC “Kurchatov Institute” – PNPI,
LHCb Collaboration

The cross section of gauge Z^0 bosons production in pp collisions can be calculated in the third order of the perturbative quantum chromodynamics (so-called N^3 LO calculations). Therefore, it is of particular interest to compare the experimentally measured cross sections with high-precision theoretical predictions. Also, the experimental measurement of Z^0 production in the kinematic region available in the LHCb experiment, which is carried out at the Large Hadron Collider (LHC), will significantly reduce the uncertainty of parton distribution functions for valence quarks, which carry both small ($x \sim 5 \cdot 10^{-5}$) and large ($x \sim 0.8$) fractions of the proton momentum. It should be noted that for the large- x region there is significant tension between the results of previous measurements, performed by SeaQuest and NuSea experiments. The goal of the study is to measure the integral and differential cross sections of Z^0 bosons production in proton–proton interactions in the rapidity region $2.0 < y^z < 4.5$, which corresponds to small (relative to the beam axis) emission angles of gauge bosons.

The Z^0 boson production is measured in the $Z^0 \rightarrow \mu^+\mu^-$ decay channel using the dataset collected by the LHCb experiment during LHC Run 2 campaign (2016–2018) at the energy in the center-of-mass system of interacting protons of 13 TeV. In total, 796 thousand $Z^0 \rightarrow \mu^+\mu^-$ candidates are selected. An analysis of transverse momentum and angular distributions is performed for the reconstructed particles. Integral, differen-

tial and doubly differential cross sections for Z^0 boson production are obtained for the following kinematic conditions that determine the fiducial volume of the detector: dimuon invariant mass from 60 to 120 GeV/ c^2 , muon transverse momenta bigger than 20 GeV/ c , muon pseudorapidity from 2.0 to 4.5.

The experimental data are in good agreement with the theoretical predictions, which are adjusted for the kinematic conditions of the experiment (Fig.). The measurement is done with the large contribution from physicists of NRC “Kurchatov Institute” – PNPI.

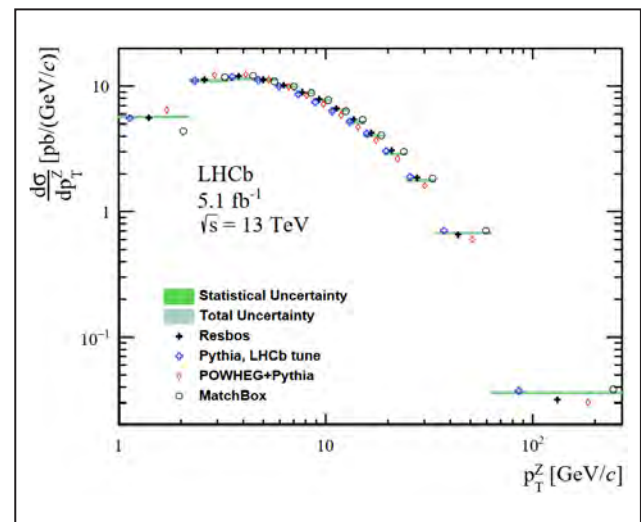

Measured single differential cross section in regions of Z boson transverse momentum (p_T^Z) for the rapidity region of $2.0 < y^z < 4.5$ in comparison with different theoretical predictions

Indications of BFKL Effect Manifestation in the CMS Experiment for the Dijet Events with Large Rapidity Intervals in pp Collisions at 2.76 TeV Energy

A.A. Vorobyev, V.T. Kim, Yu.M. Ivanov, A.Yu. Egorov, S.S. Volkov, G.E. Gavrilov, V.L. Golovtsov, E.V. Kuznetsova, P.M. Levchenko, V.A. Murzin, V.A. Oreshkin, I.B. Smirnov, D.E. Sosnov, V.V. Sulimov, L.N. Uvarov

High Energy Physics Division of NRC “Kurchatov Institute” – PNPI,
CMS Collaboration

The search for manifestations of the Balitsky–Fadin–Kuraev–Lipatov (BFKL) evolution is one of the most important tasks for the physics of particle interaction at high energies. At a high enough energy, the kinematic regime of the BFKL evolution of quantum chromodynamics (QCD) should be dominant. Therefore, it is important to know the energy value at which this regime becomes essential for further development of description of scattering processes at high energies. Moreover, the precision description of QCD effects within the BFKL evolution framework is needed for search of the new physics at extremely high energies.

The search of the BFKL evolution effects in dijet events with large rapidity intervals between jets in pp -collisions at 2.76 TeV energies was done at the CMS (Compact Muon Solenoid) experiment in the special run of the Large Hadron Collider (LHC) with a small value of probability of pp -collision overlap (pile-up). The measurement of various cross sections (inclusive, quasi-inclusive with largest rapidities – Mueller–Navelet) of dijet production with large intervals of rapidity between jets and ratios of the cross sections are the most sensitive to the BFKL effects. The NRC “Kurchatov Institute” – PNPI group proposed the version of dijet cross section with the veto on additional jets for increasing the sensitivity to BFKL effects.

In 2022, the CMS experiment detected the indication of the BFKL effects manifestation in the ratios (Fig.) in deviation of measured dijet cross section with the veto on additional jets from pre-

dictions of standard Monte Carlo generators. Further measurements of new observables available at LHC energies may shed light on the role of the BFKL evolution.

NRC “Kurchatov Institute” – PNPI made a substantial contribution to the creation of the CMS detector. Its scientists participate in constant maintenance and modernization of the detector, and are actively engaged in data analysis.

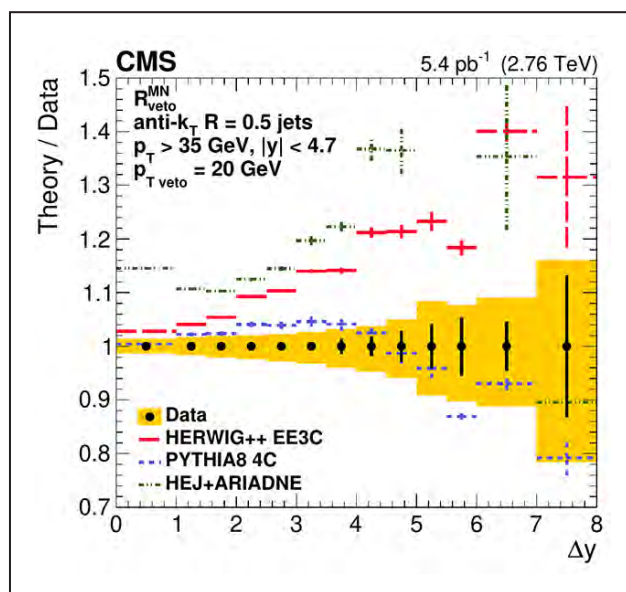

The comparison of the Monte Carlo predictions with the CMS data for the ratios of the dijet cross sections with veto on additional jets. The standard Monte Carlo generators HERWIG and PYTHIA, which provide predictions in good agreement to many other observables, fail to describe the processes of dijet production with large rapidity intervals between jets and veto on additional jets

Observation of Single-Top-Quark Production in Association with a Photon at the ATLAS Detector

S.G. Barsov, V.T. Grachev, A.E. Ezhilov, M.P. Levchenko, V.P. Maleev, Yu.G. Naryshkin, D. Pudzha, V.M. Solovyev, O.L. Fedin, G.V. Fedotov, V.A. Schegelsky

High Energy Physics Division of NRC “Kurchatov Institute” – PNPI, ATLAS Collaboration

Studying the top-quark properties is one of the key goals of the ATLAS experiment at the Large Hadron Collider (LHC). Measurements of rare processes with top-quarks provide precision tests of the Standard Model (SM) and could give hints of possible new physics beyond the SM. The search of a single-top-quark produced together with a photon ($tq\gamma$) using 139 fb^{-1} of 13 TeV proton–proton collision data collected in LHC Run 2 (2015–2018) has been performed in the ATLAS experiment. In this process, a photon can be radiated from any of the charged particles in the initial and final states, but the radiation by the top-quark before its decay is of particular interest. This process is sensitive to the top–photon coupling.

In this analysis the events with one photon, one electron or muon matched to a trigger object, one b -tagged jet from the top-quark decay, missing transverse momentum $E_T^{\text{miss}} > 30 \text{ GeV}$ from the neutrino, and a forward jet characteristic of t -channel production were selected. The main background processes in this analysis were the production of two top-quarks with a photon ($t\bar{t}\gamma$), the production of a W boson with a photon ($W\gamma$), and events with “fake photons”, which are either electrons or hadrons but are misidentified as photons.

To separate the $tq\gamma$ events from the background events neural network algorithm has been used. Specific features of the signal, like the kinematic properties of the photon and lepton, are used as the input variables for the neural network training. The comparison between experimental data and

SM prediction is shown in the Figure. The cross-section of $tq\gamma$ production at parton level is measured to be $688 \pm 23(\text{stat})^{+75}_{-71}(\text{syst}) \text{ fb}$, which is consistent with the SM prediction $515^{+36}_{-42} \text{ fb}$ at next-to-leading order in quantum chromodynamics. The observed (expected) significance of the $tq\gamma$ signal is 9.3σ (6.8σ).

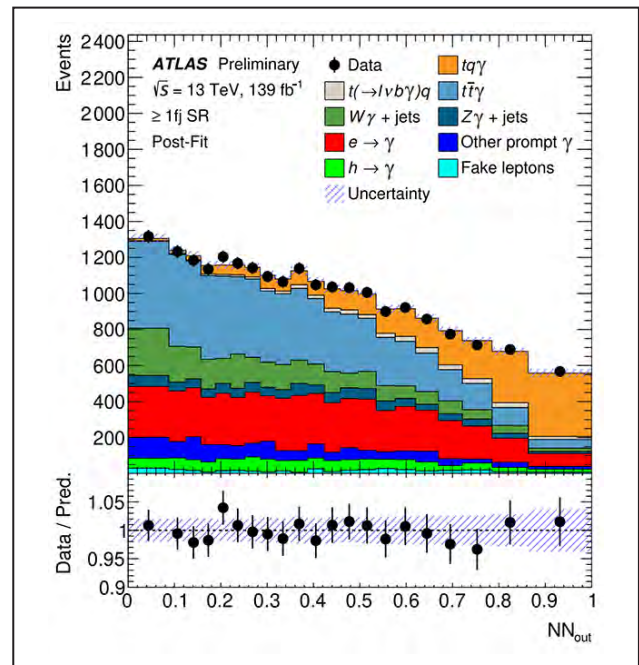

The distribution of neural network output for data and Monte Carlo predictions in the signal region with at least one forward jet obtained in the ATLAS experiment. The yield for the $tq\gamma$ signal is shown in orange and the data points are shown in black. The ratio of the observed distributions to the predicted background distributions is shown in the lower frame

Feasibility Study of τ -Lepton Anomalous Magnetic Moment Measurements with Ultraperipheral Collisions

N.A. Burmasov¹, E.L. Kryshen¹, R. Lavicka², P. Bühler²

¹ High Energy Physics Division of NRC “Kurchatov Institute” – PNPI

² The Stefan Meyer Institute for Subatomic Physics, Austria

Ultraperipheral collisions (UPC) is a unique type of heavy ion collisions that can be used to study two-photon interactions in a clean environment with strong interactions being suppressed due to large impact parameters between the incoming nuclei. In particular, UPCs give an opportunity for analyses of dilepton production process. Measurements of the anomalous magnetic moments of leptons a_l are a promising direction for searches of new physics beyond the Standard Model, as indicated by the latest results on high-precision measurements of the muon anomalous magnetic moment a_μ . Measurements of τ -anomalous magnetic moment (a_τ) are of particular interest, since a_τ appears to be a factor 280 more sensitive to effects beyond the Standard Model compared to a_μ . A short lifetime of τ -lepton prevents the use of direct measurement methods. Measurements of ditau production cross sections are sensitive to a_τ and were successfully used as an alternative by the DELPHI Collaboration to set one of the most stringent limits: $-0.052 < a_\tau < 0.013$.

Theoretical studies suggest a possibility to measure a_τ using UPCs. For cross section measurements of ditau production it is essential to select events consisting of τ -decay products while vetoing any other detector activity (Fig. 1). About 80% of τ -lepton decays result in the emission of one charged lepton or hadron accompanied by several neutral particles, while the remaining 20% of cases correspond to the emission of three charged particles in the final state. For the selection of ultraperipheral collisions, one usually explores various triggers such as registration of one or several leptons with large transverse momentum. Therefore, for the selection of τ -lepton pair production events it is feasible to explore decays

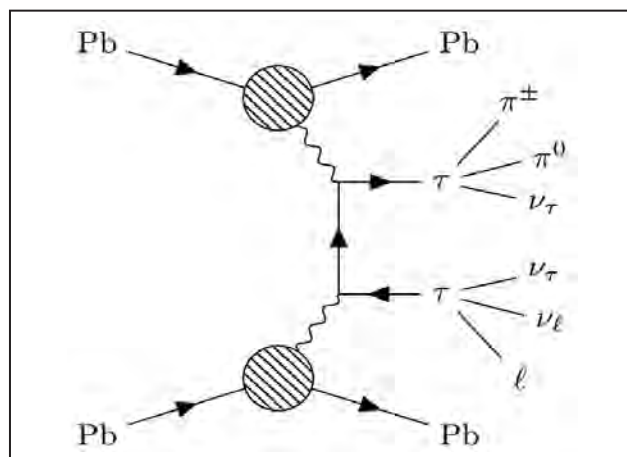

Fig. 1. τ -lepton decays in UPCs

of one τ -lepton into electron or muon with the other τ -decaying into one or three charged particles.

Using this selection strategy, ATLAS managed to extract approximately 650 signal events in all decay channels from the Run 2 data with an integrated luminosity of $L = 1.44 \text{ nb}^{-1}$ and set limits on the τ -lepton anomalous magnetic moment: $(-0.058; -0.012) \cup (-0.006; 0.025)$. The CMS Collaboration selected approximately 100 events in total using the Run 2 data with a corresponding luminosity of $L = 0.4 \text{ nb}^{-1}$ and set limits on a_τ : $(-0.088; 0.056)$. Most of τ -leptons are produced with low transverse momentum therefore significant fraction of events appears to be inaccessible for reconstruction in ATLAS and CMS experiments due to trigger limitations. The ALICE experiment has an opportunity to improve limits for a_τ significantly by reconstructing τ -decay products at low transverse momenta. To estimate possible limits with ALICE, a realistic simulation using a dedicated UPC event generator, Upcgen, has been carried out to obtain transverse momentum

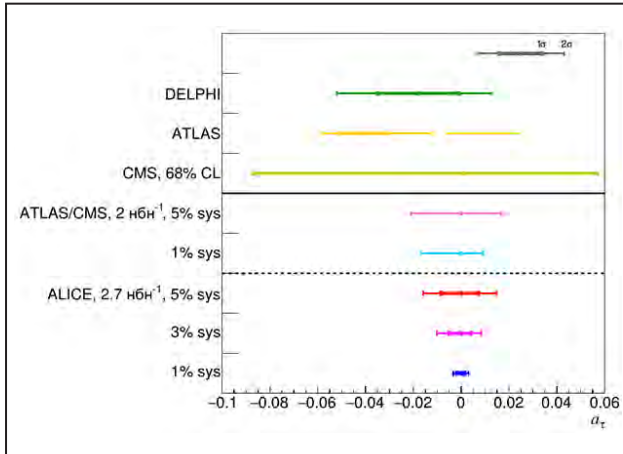

Fig. 2. Projections and experimental results for a_τ limits for the Large Hadron Collider experiments

distributions for different a_τ values for electrons originating from tau decays. The distributions were used to derive possible limits on a_τ that can be obtained with Pb–Pb collisions at $\sqrt{s_{NN}} = 5.02$ TeV and at an integrated luminosity of $L = 2.7 \text{ nb}^{-1}$, which is expected for the first year of Run 3. One year of data taking may allow ALICE to select approximately 70 000 signal events which is much larger than the data sample used for analysis in ATLAS and CMS experiments.

Projections for three possible levels of systematic uncertainties (1, 3, 5%) are shown in Fig. 2. ALICE can obtain competitive limits even in the most pessimistic scenario of 5% systematic uncertainties. The level of 1% can be approached by using measurements of ratio of ditau production cross section to cross sections of other lepton pair production processes $\gamma\gamma \rightarrow ee(\mu\mu)$ to exclude additional systematic uncertainties.

This work was supported by the RFBR (grant No. 21-52-14006) and the ASF (grant No. 5277-N).

1. ATLAS Collab. arXiv: 2204.13478.

2. CMS Collab. arXiv: 2206.05192.

3. Burmasov N., Kryshen E., Bühler P., Lavicka R. // Comput. Phys. Commun. 2022. V. 277. P. 108388.

First Observation of a Shape Isomer and a Low-Lying Strongly-Coupled Prolate Band in Semimagic ^{187}Pb

A.E. Barzakh

High Energy Physics Division of NRC “Kurchatov Institute” – PNPI,
AGFA Collaboration

In continuation of our investigation of shape coexistence in the lead region, γ -ray spectroscopy of the neutron-deficient, semimagic ^{187}Pb has been performed at the Argonne Gas-Filled Analyzer (Argonne National Laboratory). A new 5.15(15)- μs isomeric state at 308 keV above the spherical $3/2^-$ ground state is identified and classified as a shape isomer. A strongly-coupled band is observed on top of the isomer, which is nearly identical to the one built on the prolate $7/2^-$ [514] Nilsson state in the isotonic ^{185}Hg (Fig.). Based on this similarity the new isomer in ^{187}Pb is proposed to originate from the same configuration. The retarded character of the 308-keV ($7/2^-_{\text{gs}} \rightarrow 3/2^-$) transition with a deduced $B(E2) = 5.6(2) \cdot 10^{-4}$ W. u. can be well explained by the significant difference between the prolate parent and spherical daughter configurations, leading to the shape isomerism. The excitation energy of the isomer is surprisingly low, being roughly half of the excitation energies of the known 0^+ intruder bandheads in the neighboring $^{186}, ^{188}\text{Pb}$ isotopes. This effect can be related to the difference in the neutron pairing gaps, Δ , for spherical and deformed configurations. The bandhead energy E_i in an odd-A Pb nucleus can be written as: $E_i = E_{i,0} + \Delta_i$, where the index i stands for “s” (spherical), “o” (oblate) or “p” (prolate), the $E_{i,0}$ is a fictitious energy when blocking is switched off.

We use the energies of $0^+_{2,3}$ states in ^{186}Pb as a reasonable approximation for $E_{o,0}$ and $E_{p,0}$. Assuming for simplicity $E_{s,0} = 0$, we obtain $E_s = \Delta_s = 1259$ keV; the spherical pairing gap Δ_s was calculated by the standard three-point for-

mula using the binding energies for the spherical ground states of $^{186}, ^{187}, ^{188}\text{Pb}$. Deformed oblate and prolate 0^+ states in the core ^{186}Pb are at 532 and 650 keV, respectively, with strong mixing between them. Therefore, one might expect that the fictitious (without blocking) prolate bandhead in ^{187}Pb is situated somewhere between the observed mixed 0^+ states: $E_{p,0} = 595(60)$ keV. The neutron pairing gap for the deformed $7/2^-$ [514] state can be determined from the binding energies of the isotonic platinum nuclei, $\Delta_p(7/2^-$ [514]) = 1011 keV.

Thus, we obtain $E_p = 595(60) + 1011 = 1606(60)$ keV. Correspondingly, the expected excitation energy of the $7/2^-$ [514] state is $E_{\text{theor}}(7/2^-$ [514], $^{187}\text{Pb}) = E_p - E_s = 347(60)$ keV, which is in good agreement with the experimental data, $E_{\text{exp}}(7/2^-$ [514], $^{187}\text{Pb}) = 308$ keV. The same mechanism is responsible for the shape staggering in Hg nuclei and the π -shape of deformation-evolution pattern in Au isotopes near midshell $N = 104$.

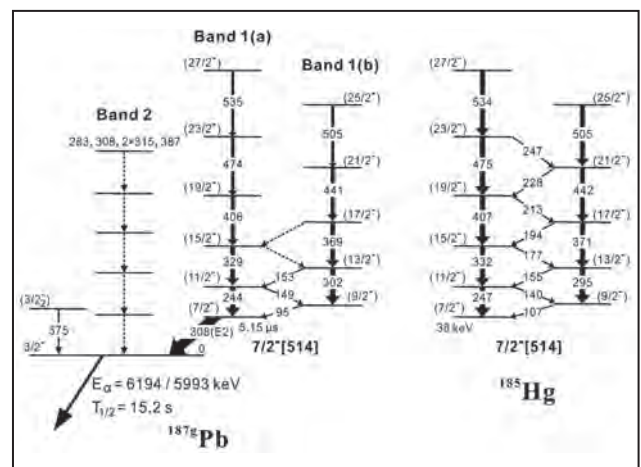

Level scheme for ^{187}Pb and partial level scheme of ^{185}Hg

Direct High-Precision Mass Spectrometry of Superheavy Elements with SHIPTRAP

O.I. Bezrodnova, Yu.I. Gusev, S.A. Eliseev, N.S. Martynova, Yu.V. Nechiporenko, Yu.N. Novikov, P.E. Filianin, S.V. Chenmarev

High Energy Physics Division of NRC “Kurchatov Institute” – PNPI, SHIPTRAP Collaboration

The SHIPTRAP system consists of two Penning ion traps installed on-line with the SHIP velocity selector separating the fusion-evaporation reaction products in targets when bombarded with ions from the UNILAC linear accelerator in GSI-FAIR (Germany). This is the only complex in the world capable of accurate measurement of the masses (total binding energies) of superheavy elements of the periodic table directly.

The products of Pb, Bi + ^{48}Ca , ^{50}Ti reactions in the form of ions enter the gas chamber, where they are inhibited and lose charge up to $1-2^+$. Then the ions are focused into a beam, bunched, slowed down and sent to a tandem of ion traps, in the first of which “purification” by mass is performed, and in the second, excitation by external radio frequency radiation of trapped ions in a space of about $100\ \mu\text{m}$ in highly homogeneous magnetic and axial electrostatic fields. The cyclotron frequency directly related to the mass of the nuclide is measured by its phase imaging on a position-sensitive detector located outside the magnetic field of the trap.

The sensitivity of the installation in the experiment was about one ion per day, corresponding to the reaction cross section about a dozen nanobarns. The relative accuracy of determining the masses was the value $\Delta m/m \sim 10^{-9}$.

The nuclides whose masses were measured directly with reference to the ^{133}Cs calibration source are shown in the fragment of the nuclide chart given in the *left part* of the Figure. Using these mass values and the energies known from the literature concerning the chains of α -decays linking the measured nuclides with other superheavy elements, a mass landscape of a part of the superheavy region was obtained. On the *right side* of the Figure, this array is shown by nuclides colored *red with black edging*. Nuclides with directly measured masses in the present work are marked with *green flags*. The obtained data confirmed our earlier conclusions about the presence of two small islands of stability at neutron values $N = 152$ and 162 on the way to the expected large island of stability of super heavy elements.

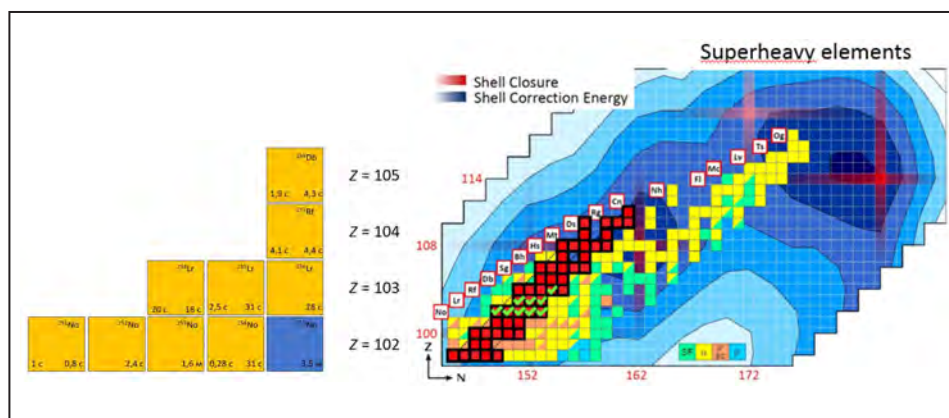

The nuclides whose masses were measured directly with reference to the ^{133}Cs calibration source are shown (*left panel*) in the fragment of the nuclide chart. The chains of alpha decays linking the measured nuclides with other superheavy elements, are shown by nuclides colored *red with black edging* (*right panel*)

Study of the Structure of Light Exotic Nuclei by Proton Elastic Scattering in Inverse Kinematics Using the Active Target IKAR

G.D. Alkhazov, A.V. Dobrovolsky, A.G. Inglessi, A.V. Khanzadeev, G.A. Korolev,
L.O. Sergeev, A.A. Vorobyev, V.I. Yatsoura

High Energy Physics Division of NRC “Kurchatov Institute” – PNPI,
PNPI–GSI Collaboration

In order to study the spatial matter distributions in light exotic nuclei, PNPI physicists proposed a new approach in 1992 – to measure the cross sections for proton–nucleus elastic scattering in inverse kinematics at an intermediate energy using the active target IKAR. The study of exotic nuclei was started by this method in 1993 and completed in 2022. The experiments were carried out at the accelerator facility in GSI Helmholtz Center for Heavy Ion Research (Darmstadt, Germany). The Figure shows the layout of the experimental set-up.

The ionization spectrometer IKAR developed at the Institute was the main component of the set-up. The beams of the nuclei under study interacted with the hydrogen nuclei of the spectrometer IKAR, which was both a gaseous target and a recoil proton detector. The signals from the IKAR electrodes gave information on the recoil proton energy T_R , its scattering angle θ_R and the coordinate of interaction Z_V . The square of the four-momentum transfer in the scattering process was calculated as $|t| = 2mT_R$, where m is the recoil proton mass, and also was determined from the projectile scattering angle θ_s , which was measured by a system

of multiwire proportional chambers PC1–PC4 arranged downstream and upstream of the IKAR detector. The scintillation counters S1–S3 were used to identify beam particles by the time of flight and by dE/dx . The VETO scintillation detector that operated in the anticoincidence mode selected only those beam particles that propagated at a distance not larger than 10 mm from the chamber axis. The ALADIN dipole magnet and a system of scintillation detectors behind it permitted to separate inelastic channels in which nuclei scattered in the reaction under study underwent break-up in the working volume of the ionization chamber. In the course of the experiments, the absolute cross sections $d\sigma/dt$ for elastic scattering of protons at an energy of 0.7 GeV/nucleon were measured in the range of momentum transfers $0.002 \leq |t| \leq 0.05$ (GeV/c)² on the ⁴He, ⁶He, ⁸He, ⁶Li, ⁸Li, ⁹Li, ¹¹Li, ¹²Be, ¹⁴Be, ¹²C, ¹⁴C, ¹⁵C, ¹⁶C, ¹⁷C, and ⁷Be, ⁸B nuclei.

The measured cross sections were analysed using the Glauber multiple scattering theory and applying four parameterizations of phenomenological nuclear density distributions labeled

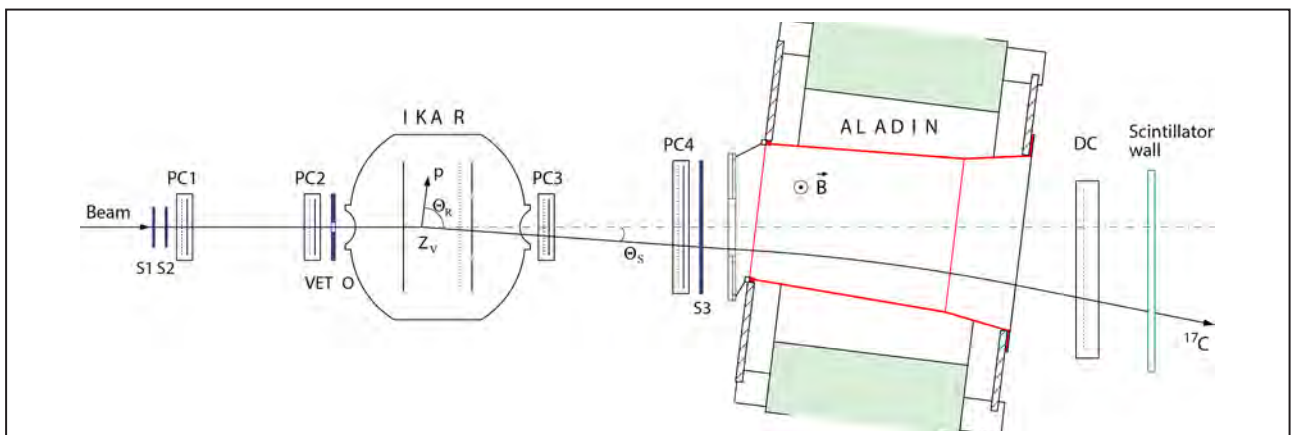

Schematic layout of the experimental set-up. Only one of six IKAR modules is shown

as SF (symmetrized Fermi), GH (Gaussian–Halo), GG (Gaussian–Gaussian) and GO (Gaussian–oscillator). Each of these distributions contains two free parameters, which were determined by fitting the calculated cross sections to the experimental data. As a result of the data analysis, the nuclear matter density distributions and the root-mean-square (rms) matter radii R_m were determined. The values of R_m obtained by the method of elastic scattering of protons within the limits of measurement errors basically agree with the results found in the analyses of the total reaction or interaction cross sections (Table). A characteristic feature of the method of our work is the ability to determine the sizes of the nuclear core R_c and of the rms radius of the halo R_h (of the valence nucleons R_v). The ratio $\kappa = R_v/R_c$ can serve as a quantitative criterion for the halo existence.

In the studied nuclei, the largest neutron halo was observed in ^{11}Li , for which the maximum value

of $\kappa = 2.7(3)$ was obtained. A neutron halo, and, accordingly, a relatively large value of κ was also found for the ^6He ($\kappa = 1.8(3)$), ^{14}Be ($\kappa = 1.9(2)$), and ^{15}C ($\kappa = 1.8(2)$) nuclei. Though the binding energy S_n in the ^{17}C nucleus is small ($S_n = 0.728$ MeV), the determined value of κ for this nucleus ($\kappa = 1.6(2)$) does not indicate the existence of a halo. The absence of a halo in the ^{17}C nucleus is explained by the fact that in ^{17}C the valence neutron is in the d -state. In the case of the ^8B nucleus, a proton halo is observed, and its size is determined as $\kappa = 1.9(1)$.

The method proposed at NRC “Kurchatov Institute” – PNPI for studying the structure of light exotic nuclei proved to be highly efficient and made it possible for us to study the size and the structure of the $^4, 6, 8\text{He}$, $^6, 8, 9, 11\text{Li}$, $^7, 12, 14\text{Be}$, ^8B , and $^{12, 14, 15, 16, 17}\text{C}$ nuclei (see the Table).

Table. Results obtained for isotope nuclei He, Li, Be, B, C*

Nucleus	Proton elastic scattering				Reaction (interaction) cross sections
	R_m , fm	R_c , fm	R_v , fm	δ_{np} , fm	R_m , fm
^4He	1.49(3)	–	–	0.06(6)	1.57(4)
^6He	2.45(10)	1.88(12)	3.31(28)	0.74(14)	2.50(5)
^8He	2.53(8)	1.55(15)	3.22(14)	0.83(10)	2.52(3)
^6Li	2.44(7)	2.11(17)	3.00(34)	–0.02(15)	2.36(3)
^8Li	2.50(6)	2.48(7)	2.58(48)	0.46(12)	2.39(6)
^9Li	2.44(6)	2.20(6)	3.12(28)	0.48(11)	2.34(6)
^{11}Li	3.71(20)	2.53(3)	6.85(58)	1.72(26)	3.50(9)
^7Be	2.42(4)	1.86(14)	3.01(19)	–0.23(10)	2.36(6)
^{12}Be	2.71(6)	2.36(6)	4.00(28)	0.47(9)	2.59(6)
^{14}Be	3.25(11)	2.77(6)	5.28(43)	1.12(15)	3.10(15)
^8B	2.58(6)	2.25(3)	4.24(25)	–0.51(9)	2.61(8)
^{12}C	2.34(5)	–	–	0.00(10)	2.35(2)
^{14}C	2.42(5)	–	–	0.07(9)	2.33(7)
^{15}C	2.59(5)	2.41(5)	4.36(38)	0.36(9)	2.54(4)
^{16}C	2.70(6)	2.41(5)	4.20(26)	0.46(10)	2.74(3)
^{17}C	2.68(5)	2.57(5)	4.05(47)	0.39(9)	2.76(3)

* The thicknesses of the neutron skins $\delta_{np} = R_n - R_p$ (where R_p are the rms proton radii) obtained by combining our results on R_m with the known values of the nuclear charge radii are also shown.

Prospects for the Study of Extreme States of Nuclear Matter in MPD Experiment at NICA Accelerator

N.A. Burmasov, A.T. Dyachenko, M.B. Zhalov, G.A. Zalite, D.A. Ivanishchev, D.O. Kotov, E.L. Kryshen, M.V. Malaev, A.Yu. Riabov, V.G. Riabov, Yu.G. Ryabov, O.L. Fedin, A.V. Khanzadeev
High Energy Physics Division of NRC "Kurchatov Institute" – PNPI

A megascience project NICA (Nuclotron based Ion Collider fAcility) is at the final stage of construction at Joint Institute for Nuclear Research (JINR, Dubna). The project includes the accelerator facility and several experimental apparatuses. The accelerator facility consists of heavy ion and proton sources, linear accelerators, superconducting ring accelerators Booster and Nuclotron, and two superconducting rings of the NICA collider, having a length of ~ 500 m. Ion beams of the NICA collide in two interaction points where two experimental apparatuses MPD (multipurpose detector) and SPD (spin physics detector) will be located.

The SPD experiment is currently under development and is aimed to study spin physics in collisions of polarized proton and deuteron beams. The MPD experiment is designed to study heavy-ion collisions in the energy range $\sqrt{s_{NN}} = 4\text{--}11$ GeV at the maximum luminosity of heavy ion beams of $10^{27} \text{ cm}^{-2} \cdot \text{s}^{-1}$. The beam extracted from the Nuclotron can be transported to the BM@N (baryonic matter at Nuclotron) detector – a fixed-target experiment that began operation in 2018. In the first years of operation, the NICA collider will provide Bi + Bi collisions at $\sqrt{s_{NN}} = 9.2$ GeV. The luminosity of the beams will be two orders of magnitude lower than the designed value and will correspond to a nuclear collision rate of ~ 50 Hz.

The collisions of heavy nuclei at the energies of NICA are used to study the quantum chromodynamics phase diagram in the regime of moderate temperatures and high baryon densities, exceeding the density of normal nuclei by a factor of 5–8. Theoretical models predict that a first-order phase transition from hadronic matter to the quark–gluon plasma can occur under such conditions, as well as the existence of the critical point. Research in this area of the phase diagram

is closely related to cosmology, since such states can be realized in the centers of compact neutron stars, as well as during their merger.

The HADES and CBM experiments in Germany, NA61 at the European Organization for Nuclear Research will operate in the energy range of NICA facility. The energy scan program (BES I and BES II) was conducted at Relativistic Heavy Ion Collider in the USA in the same energy range, the collected data sets are currently being processed. Thus, BM@N and MPD experiments at NICA facility will operate in a fairly competitive environment. The main advantage of the MPD experiment is the possibility to investigate interaction of different system size (pp , $p\text{--}A$, $A\text{--}A$) in addition to the energy scan. MPD collider experiment will have a large and uniform acceptance in all colliding systems, which distinguishes it from the fixed-target experiments.

Great progress has been achieved in the construction of NICA accelerator facility in the last years. The fourth cycle of operation of NICA accelerator facility ended in the beginning of 2023, which involved the operation of the ion source, the linear accelerator, Booster and Nuclotron superconducting ring accelerators. The accelerator facility in this configuration was used to accelerate the beam of heavy ions (Xe) and transport it to the experimental hall of BM@N detector. The accelerator facility operated for several months and the BM@N experiment collected more than 500 million Xe–CsI collisions at beam energies of 3.8 and 3 A · GeV for physical analyses. The installation of superconducting magnets in the tunnel of the NICA collider is underway at present time. The first technological run of the collider should take place to test various subsystems without beams so far at the end of 2023. It is

planned to conduct the first run of the entire facility with real beams in 2024.

The schematic view of the MPD detector is shown on the *left side* of the Fig. The detector was designed as a 4π spectrometer capable of detecting charged hadrons, electrons and photons in heavy-ion collisions at high luminosity. The apparatus includes a high-volume time-projection chamber (TPC) for reconstruction of charged particle tracks and their identification in the region of small and intermediate momenta by measuring the ionization losses of particles in the gas volume of the detector, time-of-flight (ToF) system for particles identification in the region of intermediate and high transverse momenta, as well as an electromagnetic calorimeter (ECAL) for measuring photons and electrons. The detector subsystems are located inside a superconducting solenoid with a field of 0.5 T. The forward detectors FFD (fast forward detectors) and FHCAL (forward hadron calorimeter) will be used for triggering, measuring the event centrality and the reaction plane. The MPD detector will be upgraded to include an internal silicon tracker for vertex reconstruction and forward spectrometers later.

All MPD detector subsystems of the first phase are in the final stages of production and testing. One can expect commissioning of the MPD detector and the first data taking in the end of 2024. The physical program of the MPD experiment has much in common with the programs of other heavy-ion experiments. The main goal of the research is to obtain constraints for the equation of state of dense nuclear matter and to search for partonic degrees of freedom and critical signatures at high baryon densities.

The employees of the High Energy Physics Division carry out a number of works for the MPD experiment. The gas system of the main MPD tracking detector, the TPC, was constructed and delivered to JINR. Experimental methods are being developed for the measurements of various physical phenomena, such as the production of short-lived resonances, photons, dielectron continuum, identified hadrons and vector mesons in collisions of heavy nuclei. Software was developed for reconstruction of the signals measured in the ECAL. Specialists from NRC “Kurchatov Institute” – PNPI serve as conveners of the physics working groups and members of the executive council.

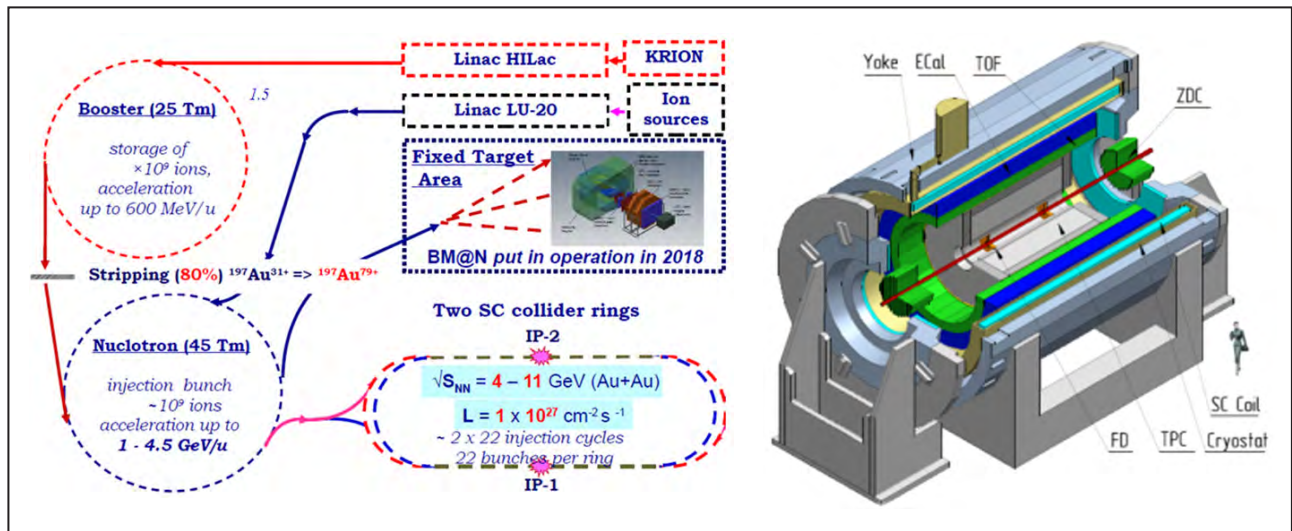

Schematic view of NICA facility (left) and experimental apparatus MPD (right)

Nonequilibrium Hydrodynamic Approach to Describing the Emission of High-Energy Secondary Particles in Intermediate-Energy Heavy-Ion Collisions

A.T. D'yachenko¹, I.A. Mitropolsky²

¹ High Energy Physics Division of NRC "Kurchatov Institute" – PNPI

² Neutron Research Division of NRC "Kurchatov Institute" – PNPI

With the aim of developing the hydrodynamic approach to describing collisions of intermediate-energy heavy ions, it is proposed to solve simultaneously the equations of hydrodynamics and the kinetic equation. This makes it possible to include the nonequilibrium component and to describe successfully the double-differential cross sections of the emission of cumulative protons, pions, and photons in collisions of carbon nuclei with a beryllium target in the energy range of of 2.0–3.2 GeV/nucleon. The resulting description of the experimental data turns out to be better than in cascade models and models of quantum molecular dynamics (Fig.).

It is of importance that effects of nuclear viscosity, found above in the relaxation τ -approximation for the kinetic equation, have been included

in our consideration, as well as corrections for the microcanonical distribution, which manifest themselves in the region of high-energy "tails" of proton spectra. In the region of low proton momenta, fragmentation, which we take into account within the statistical fragmentation model, makes a dominant contribution to the cross section. Our calculations reproduce experimental data on the proton and pion yields both for medium-mass and heavy nuclei at intermediate and high energies of colliding nuclei and therefore admit application in the energy range covered by the NICA accelerator facility under construction in Dubna. The successful description of the spectra of hard photons indicates that our approach is likely to include effects of short-range correlations.

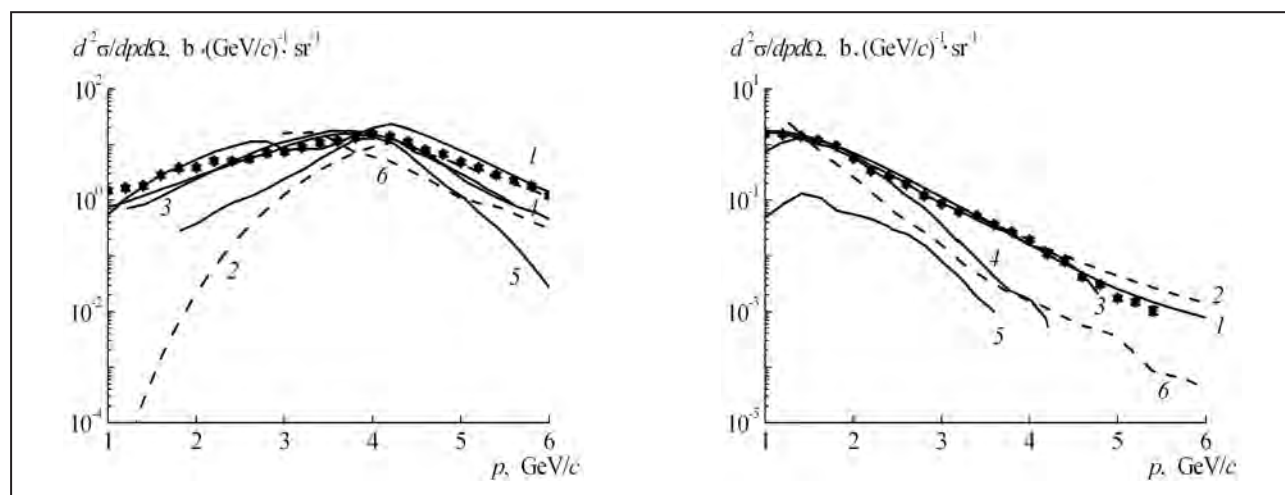

Laboratory-momentum distributions of protons (*left*) and negative pions (*right*) emitted in the $^{12}\text{C} + {}^9\text{Be} \rightarrow p(\pi^-) + X$ reaction at the ^{12}C ion energy of 3.2 GeV/nucleon at an angle of 3.5° . The experimental data obtained in the FRAGM experiment (NRC "Kurchatov Institute" – ITEP) are shown by dots. Curve 1 is the result of calculations within the framework of the hydrodynamic approach; curve 2 is the same, but without taking into account the correction for the microcanonical distribution. Curves 3–5 are the results of calculations based on transport codes: curve 3 is a cascade model; curve 4 is a transport model of quark–gluon strings; curve 5 is a model of quantum molecular dynamics embedded in the GEANT4 package. Curve 6 is our calculation based on the HSD (hadron string dynamics) code

1. D'yachenko A.T., Mitropolsky I.A. // Phys. Atom. Nucl. 2022. V. 85. Iss. 6. P. 1053–1062.

2. D'yachenko A.T., Mitropolsky I.A. // Phys. Part. Nucl. 2022. V. 53. No. 2. P. 505–512.

First Measurement of Solar Neutrino Directionality with Energies Below 1 MeV by the Borexino Detector

A.V. Derbin, I.S. Drachnev, I.S. Lomskaya, V.N. Muratova, N.V. Niyazova, D.A. Semenov, E.V. Unzhakov

Neutron Research Division of NRC “Kurchatov Institute” – PNPI, Borexino Collaboration

The measurement of solar neutrino flux with energies below 1 MeV was performed by the Borexino detector by means of Čerenkov radiation registration. The analysis employs the differences in temporal dependence of radiation probability between Čerenkov and conventional scintillation photons (Fig. 1). The result is obtained via a new approach that compares the registered position of a given photon against the corresponding relative position of the Sun at the moment of registration (Fig. 2). Using the events from 0.54–0.74 MeV selected by Čerenkov radiation, it was established that the rate of ${}^7\text{Be}$ neutrino interaction

amounted to 52 ± 13 events/day per 100 t of scintillator. This result is in agreement with predictions of the Standard Solar Model and previous spectrometric results obtained by Borexino. For the first time we have demonstrated the possibility of Čerenkov radiation analysis for sub-MeV solar neutrinos in a large-volume scintillation detector with high light yield. This result confirms the possibility of hybrid event reconstruction, which simultaneously makes use of both, Čerenkov and scintillation photons.

This work has been supported by RSF grant No. 21-12-00063.

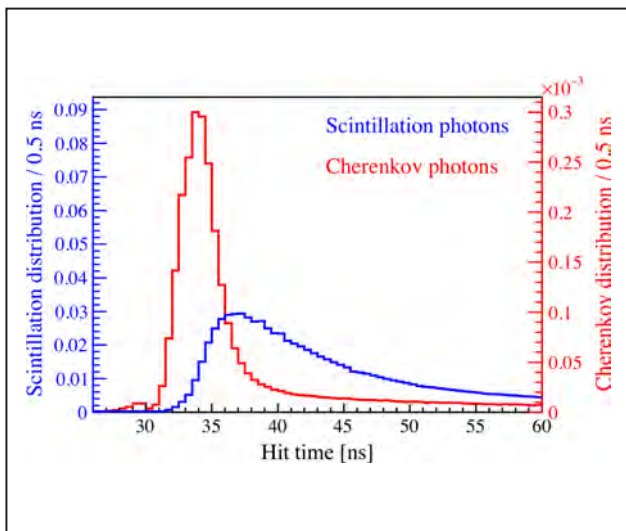

Fig. 1. Temporal dependence of radiation probability for Čerenkov and scintillation photons in Borexino scintillator. The areas of both curves are normalized to unity for visualization purpose, although the real fraction of Čerenkov photons is only 0.4%

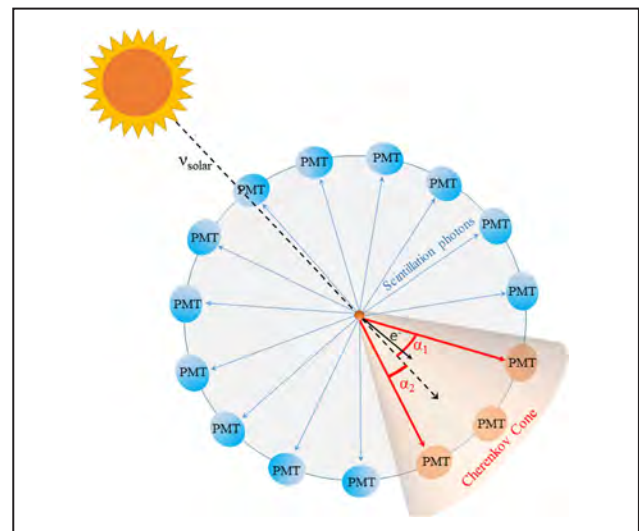

Fig. 2. Schematic representation of solar neutrino scattering geometry, depicting the propagation cone of Čerenkov photons

1. Borexino Collab., Agostini M., ..., Derbin A., ..., Lomskaya I., ..., Muratova V., ..., Semenov D., ..., Unzhakov E. et al. // Phys. Rev. Lett. 2022. V. 128. P. 091803.
2. Borexino Collab., Agostini M., ..., Derbin A., ..., Lomskaya I., ..., Muratova V., ..., Semenov D., ..., Unzhakov E. et al. // Phys. Rev. D. 2022. V. 105. P. 052002.

A New Limit on Axion–Electron Coupling Constant for Solar Axions

A.V. Derbin¹, I.S. Drachnev¹, M.S. Mikulich¹, V.N. Muratova¹, E.V. Unzhakov¹, Yu.M. Gavriluk², A.N. Gangapshev², V.V. Kazalov², V.V. Kuzminov², D.A. Tekueva², S.P. Yakimenko²

¹ Neutron Research Division of NRC “Kurchatov Institute” – PNPI

² Institute for Nuclear Research of RAS

A new light pseudoscalar particle, an axion, appeared in theory as a result of attempt to solve the strong CP problem. Despite the lack of positive registration by numerous experiments, axions still remain a well motivated candidate for dark matter particles. Appealing astrophysical hints for axion existence are related with anomalous transparency of the Universe for high-energy γ -quanta and with excessive cooling rate of particular star clusters in comparison with theoretical predictions.

In this work we present the results of experimental search for resonant excitation of the first nuclear level of ^{83}Kr nucleus at 9.4 keV by solar axions, produced via processes depending on axion–electron coupling (g_{Ae} constant). The particles appearing

as a result of nuclear level discharge (γ -quanta, X-rays and Auger/conversion electrons) were registered by gaseous proportional counter, located at the low-background facility of the Baksan Neutrino Observatory. The energy spectrum obtained during 777 days of exposure is given in Fig. 1. No statistically prominent axion peak at 9.4 keV was observed. As a result, the new upper limits on axion–electron and axion–nucleon coupling constants were set $|g_{\text{Ae}}(g_{\text{AN}}^3 - g_{\text{AN}}^0)| \leq 1.50 \cdot 10^{-17}$ (90% c. l.) (Fig. 2), thus yielding the new limits on axion mass of $m_{\text{A}} \leq 320$ eV and $m_{\text{A}} \leq 4.6$ eV in KSVZ- and DFSZ-axion models, correspondingly.

This work has been supported by RSF grant No. 22-22-00017.

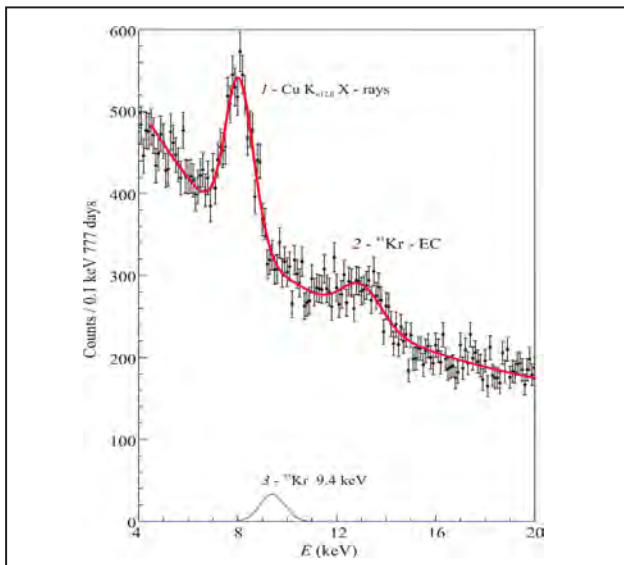

Fig. 1. The energy spectrum obtained by proportional counter and the results of fitting by theoretical shape. The expected axion peak at 9.4 keV with 3σ significance is given for visual comparison (curve 3)

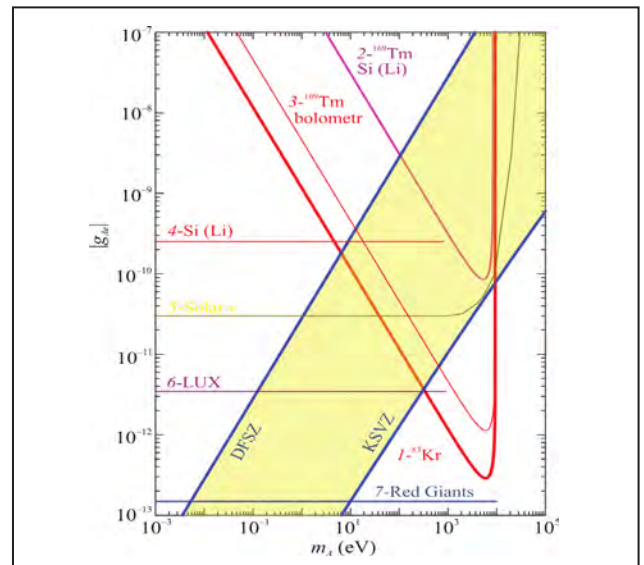

Fig. 2. The upper limits on g_{Ae} constant obtained in current work (1) in comparison with previous axion searches: resonant absorption by ^{169}Tm nuclei (2, 3) axioelectric effect on Si(Li) (4) and Xe (6) and also with neutrino luminance of the Sun (5) and astrophysical bounds (7)

A Search for Low-Energy Signals Associated with Fast Radio Bursts in the Borexino Detector

A.V. Derbin, I.S. Drachnev, I.S. Lomskaya, V.N. Muratova,
N.V. Niyazova, D.A. Semenov, E.V. Unzhakov

Neutron Research Division of NRC “Kurchatov Institute” – PNPI,
Borexino Collaboration

A phenomenon of fast radio burst (FRBs) is a transient and extremely intense radio-frequency impulse with duration of several milliseconds. The first registration of an FRB instance occurred in 2007. The variance of the radio-frequency signal suggested its extragalactic origin. Although there are several FRB models including some exotic ones, such as the assumed conversion of an axion star to photons in the presence of a magnetic field, the actual nature of FRB genesis remains unclear. The total sky rate of FRB occurrences is estimated as 2 000 events per day.

In this work we have performed a search for neutrino events registered by the Borexino detector during 2007–2021 time period in correlation with 42 of the most intense FRBs. We selected events with energies above 250 keV inside of the ± 1000 s

interval around the registration time of a given FRB instance (Fig. 1). In addition, we employed an alternative approach based on the identification of specific spectral signatures of recoil electrons produced by neutrino scattering that are present in the total Borexino spectrum. Two shapes of expected neutrino spectra were considered: a monoenergetic line and a supernova flare spectrum. Also, the same analysis was performed for electron antineutrino flux, which is registered by the inverse β -decay reaction. There was no statistically significant excess of events above the background level. As a result, we have set the most stringent upper limits on FRB-related neutrino fluences of all flavors within 0.5–5.0 MeV energy interval (Fig. 2).

This work has been supported by RSF grant No. 21-12-00063.

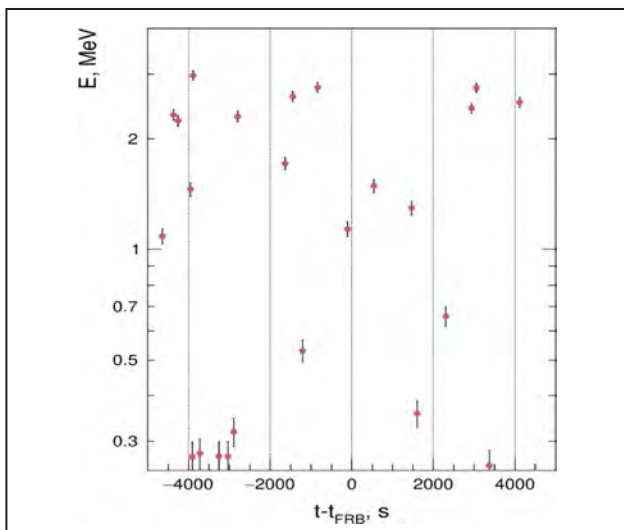

Fig. 1. Events registered by the Borexino detector with energies above 0.25 MeV within ± 5000 s time interval around FRB 200428 (the brightest fast radio burst within our galaxy)

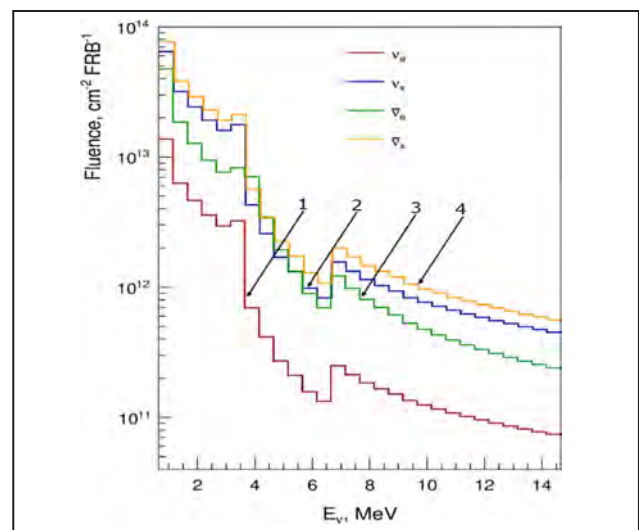
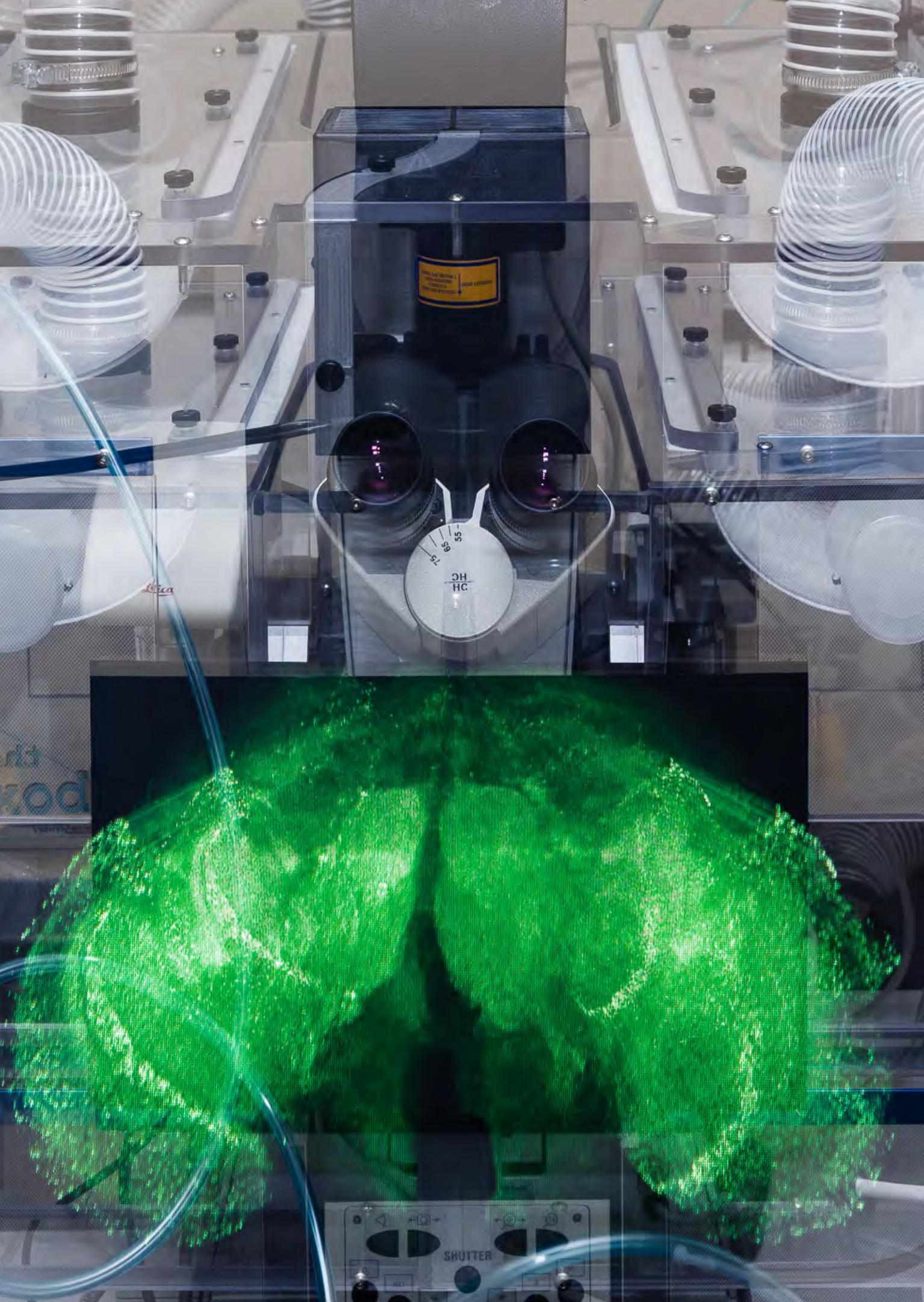

Fig. 2. The upper limits on fluences of monoenergetic neutrinos from 42 of the most intense fast radio bursts (90% c. l.)



Bitte nicht berühren!
Bitte nicht berühren!
Bitte nicht berühren!

Leica

75 80 85
DH
HC

SHUTTER

Biological Research

- 66 Impaired Sphingolipid Hydrolase Activities in Dementia with Lewy Bodies and Multiple System Atrophy
- 67 Could Blood Hexosylsphingosine Be a Marker for Parkinson's Disease Linked with *GBA1* Mutations?
- 69 Reduced Expression of α -Synuclein Contributes to Slowing the Development of Early Neuropathology in the *Drosophila* Model of Parkinson's Disease
- 70 Extracellular Particles as Carriers of Cholesterol Not Associated with Lipoproteins
- 71 Study of the Structure of Complexes of Myeloperoxidase, Ceruloplasmin, and α -Thrombin, Methods of Molecular Research and SANS

Impaired Sphingolipid Hydrolase Activities in Dementia with Lewy Bodies and Multiple System Atrophy

T.S. Usenko^{1,2}, K.A. Senkevich^{1,2}, A.I. Bezrukova¹, G.V. Baydakova³, K.S. Basharova¹, A.S. Zhuravlev¹, E.V. Gracheva⁴, A.V. Kudrevatykh⁴, I.V. Miliukhina^{2,4}, I.V. Krasakov⁵, L.A. Khublarova⁶, I.V. Fursova⁶, D.V. Zakharov⁶, A.A. Timofeeva², Yu.A. Irishina⁴, E.I. Palchikova⁶, N.M. Zalutskaya⁶, A.K. Emelyanov^{1,2}, E.Yu. Zakharova³, S.N. Pchelina^{1,2,7}

¹ Molecular and Radiation Biophysics Division of NRC “Kurchatov Institute” – PNPI

² Pavlov First Saint Petersburg State Medical University

³ Research Center for Medical Genetics

⁴ Bekhtereva Institute of the Human Brain of RAS

⁵ Nikiforov All-Russian Center for Emergency and Radiation Medicine of the EM of Russia

⁶ Bekhterev National Research Medical Center for Psychiatry and Neurology

⁷ Institute of Experimental Medicine

The synucleinopathies are a group of neurodegenerative diseases that include Parkinson’s disease (PD), dementia with Lewy bodies (DLB) and multiple system atrophy (MSA). The pathogenesis of synucleinopathies is characterized by the accumulation of α -synuclein protein in brain. However, molecular mechanisms of synucleinopathies are unknown. Recent data have shown that DLB and PD are characterized by alterations of lysosomal enzyme activities, which confirms the latest hypothesis about the pivotal role of lysosome dysfunction in synucleinopathies pathogenesis. The assessment of activity of lysosomal enzymes in MSA patients has not been previously conducted.

163 PD patients, 44 DLB patients, 30 MSA patients, and 159 individuals without neurological disorders (controls) were enrolled in the current study. Enzyme activities (GCCase, GLA, ASMase) and concentration of corresponding substrate sphingolipids (HexSph, LysoGb3, LysoSM) were estimated by liquid chromatography tandem-mass spectrometry (LC-MS/MS) in blood.

Expression levels of genes *GBA*, *SMPD1*, *GLA*, encoding the corresponding study enzymes (GCCase, GLA ASMase) were analyzed by real-time PCR with TaqMan probes in CD45+ peripheral blood cells selected by magnetic sorting.

Expression levels of genes *SMPD1*, that encodes acid sphingomyelinase (ASMase), was significantly decreased in CD45+ blood cells of MSA patients compared to controls. At the same time, ASMase activity was decreased in MSA, DLB patients compared to PD patients and in MSA patients compared to controls. Increased hexosylsphingosine (HexSph) concentration was observed in MSA and DLB patients when compared with PD patients and controls.

This study is fundamental for further studies of the role of sphingolipid metabolism in synucleinopathies pathogenesis. The alteration of HexSph concentration may be considered as a potential biomarker for MSA and DLB.

The study was supported by Russian Foundation for Basic Research grant No. 20-015-00116.

Could Blood Hexosylsphingosine Be a Marker for Parkinson's Disease Linked with *GBA1* Mutations?

A.E. Kopytova¹, T.S. Usenko^{1,2}, G.V. Baydakova³, M.A. Nikolaev^{1,2}, K.A. Senkevich^{1,2}, A.D. Izyumchenko¹, A.A. Tyurin², I.V. Miliukhina^{2,4}, A.K. Emelyanov^{1,2}, E.Yu. Zakharova³, S.N. Pchelina^{1,2}

¹ Molecular and Radiation Biophysics Division of NRC "Kurchatov Institute" – PNPI

² Pavlov First Saint Petersburg State Medical University

³ Research Center for Medical Genetics

⁴ Bekhtereva Institute of the Human Brain of RAS

Mutations in the *GBA1* gene cause autosomal recessive disease Gaucher disease (GD) and are a high-risk factor for Parkinson's disease (PD). The risk of developing PD increases by 8–10 times in heterozygous *GBA1* mutations carriers. The *GBA1* gene encodes the lysosomal enzyme glucocerebrosidase (GCase), which cleaves lysosphingolipids, namely glucosylcerebroside (GlcCer) to glucose and ceramide. In GD a decrease in the activity of GCase in lysosomes leads to the accumulation of GlcCer and glucosylsphingosine (GlcSph) formed during deacetylation of GlcCer. With the development of PD in *GBA1* mutations carriers (GBA-PD), there is also a slight but statistically significant decrease in GCase activity and an increase in the concentration of hexosylsphingosine (HexSph) (a mixture of GlcSph and galactosylsphingosine (GalSph)) in blood (Fig.).

Mutations in the *GBA1* gene have low penetrance in the development of PD. Thus, in patients aged 80 years and older, 9–30% of *GBA1* mutation carriers develop the clinical picture of the disease. It is still unknown what triggers the development of PD in carriers of mutations in the *GBA1* gene.

We measured HexSph concentration and GCase activity in dry blood spots (DBSs) from patients with GD, patients with PD with *GBA1* mutations, healthy *GBA1* mutations carriers, patients with sporadic PD and control subjects. GCase activity and HexSph concentration were measured from DBSs by liquid chromatography coupled with tandem mass spectrometry. As expected, patients with GD showed marked decrease in DBS GCase activity and an increase in HexSph concentration (Table).

A decrease of GCase activity and an increase of HexSph concentration in blood were also shown in

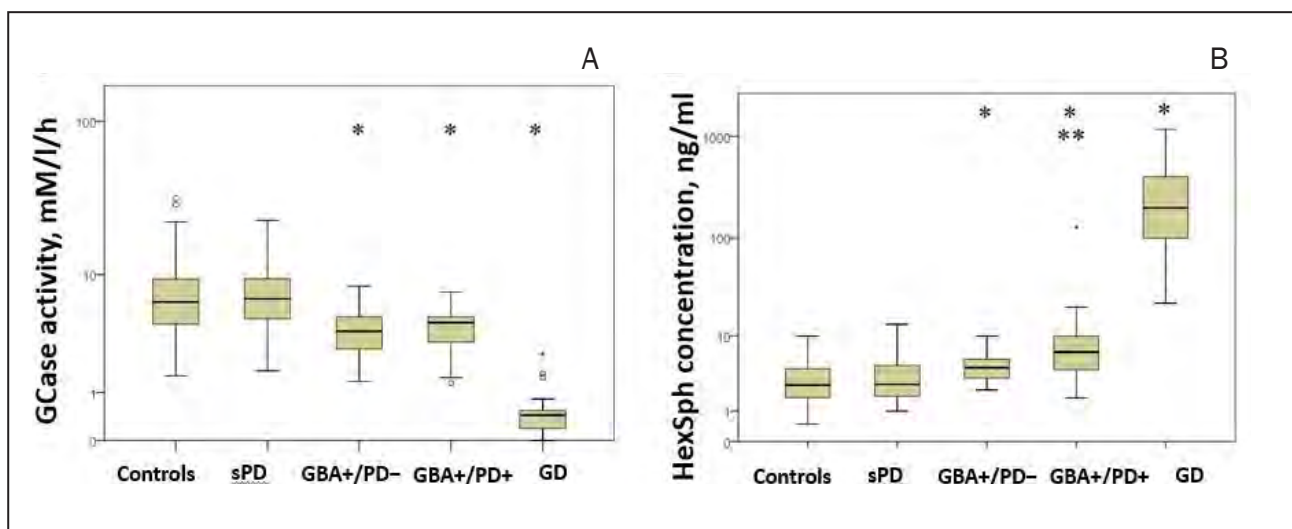

GCase activity (A) and HexSph concentration (B) in blood of the studied groups of patients. * $p < 0.05$ compared to the control, ** $p < 0.05$ compared to GBA+/PD-

patients with GBA+/PD+ and GBA+/PD- compared with patients with sporadic PD (sPD) and control subjects independent from the type of GBA1 mutation (see Table). However, HexSph level was slightly higher in patients with GBA+/PD+ compared with GBA+/PD- ($P < 0.014$). It is interesting to note that when divided by type of mutation, an increase in blood HexSph concentration remained significantly

associated with PD only in carriers with “mild” GBA1 mutations ($P < 0.006$).

Our results allowed us to make the conclusion that blood HexSph level might be associated with PD in “mild” GBA1 mutation carriers.

The work was supported by Russian Science Foundation grant No. 19-15-00315.

Table. Clinical and biochemical data of the studied groups

Patient group	Sex (m/f)	Age, mean \pm SD, years	Mutations in the GBA1 gene	GCase activity, mM/l/h, median (min-max)		HexSph concentration, ng/ml, median (min-max)	
Controls (N = 170)	70/100	62.6 \pm 10.3	N/a	6.39 (1.54–32.13)		2.59 (0.49–9.87)	
sPD (N = 177)	68/109	64.4 \pm 10.1	N/a	6.74 (1.73–23.01)		2.63 (0.98–13.23)	
GBA+/PD- (N = 21)	8/13	55.2 \pm 2.8	11 – N370S 1 – N227S 6 – L444P 1 – L327P 1 – M124T 1 – G241R	3.84 (1.34–8.31)		4.32 (2.22–9.88)	
				GBA+/PD- “mild” GBA1 mutation (N = 15)	GBA+/PD- “severe” GBA1 mutation (N = 6)	GBA+/PD- “mild” GBA1 mutation (N = 15)	GBA+/PD- “severe” GBA1 mutation (N = 6)
GBA+/PD+ (N = 18)	8/10	59.9 \pm 2.5	10 – L444P 8 – N370S	4.49 (1.29–7.53)		6.65 (1.68–127.44)	
				GBA+/PD+ “mild” GBA1 mutation (N = 8)	GBA+/PD+ “severe” GBA1 mutation (N = 9)	GBA+/PD+ “mild” GBA1 mutation (N = 8)	GBA+/PD+ “severe” GBA1 mutation (N = 9)
GD (N = 37)	16/21	22.0 \pm 3.56	N/a	0.29 (0.01–0.66)		634.68 (185.76–1523.40)	
p-value	0.985	0.151	N/a	< 0.05		< 0.05	

Reduced Expression of α -Synuclein Contributes to Slowing the Development of Early Neuropathology in the *Drosophila* Model of Parkinson's Disease

I.M. Golomidov, E.M. Latypova, E.V. Ryabova, O.I. Bolshakova, A.E. Komissarov, S.V. Sarantseva
Molecular and Radiation Biophysics Division of NRC "Kurchatov Institute" – PNPI

Parkinson's disease (PD) is a neurodegenerative disease characterized by the formation of Lewy bodies and progressive loss of dopaminergic neurons in the substantia nigra of the brain. Lewy bodies are predominantly composed of the protein α -synuclein, which plays a key role in the pathophysiology of PD. Alpha-synuclein is encoded by the *SNCA* gene located on chromosome 4. Currently, six mutations in the *SNCA* gene associated with the familial form of the disease have been described. Expression of the human *SNCA* gene as well as its forms with A30P and A53T mutations in *Drosophila melanogaster* using the temperature-dependent UAS-GAL4/GAL80 system for certain time intervals allows us to assess the degree of neuropathology development.

In our study, *SNCA* gene expression was triggered only during the adult developmental stage of *Drosophila* lines for one or two weeks, followed by suppression of gene expression up to the fourth week of fly life. The extent of neurodegeneration was demonstrated to be significantly dependent on the duration of *SNCA* gene expression. Expression

of the gene for a longer period of time caused death of dopaminergic neurons, reduction of dopamine levels and locomotor activity. In this case, the neurodegenerative processes we observed were associated with accumulation in the *Drosophila* brain. Importantly, suppression of *SNCA* gene expression resulted in the elimination of the soluble fraction of α -synuclein, in contrast to the insoluble fraction. After blocking *SNCA* gene expression, we did not observe further neuropathology. Thus, we tend to speculate that the soluble form of α -synuclein contributes more to the development of pathology in the early stages of the disease.

In this work, we studied the effects of triggering and suppressing *SNCA* gene expression on the development of the neurodegenerative process in *Drosophila melanogaster*. Such studies are necessary to understand the onset and progression of pathological changes in PD and other synucleopathies, as well as to determine the time intervals of "therapeutic windows", when the developing degenerative changes are still reversible, and the applied therapy is most effective.

Extracellular Particles as Carriers of Cholesterol Not Associated with Lipoproteins

S.B. Landa^{1,2}, N.A. Verlov¹, N.D. Fedorova¹, M.V. Filatov¹, R.A. Pantina¹, V.S. Burdakov¹, E.Yu. Varfolomeeva¹, V.L. Emanuel²

¹ Molecular and Radiation Biophysics Division of NRC "Kurchatov Institute" – PNPI

² Pavlov First Saint Petersburg State Medical University

Extracellular particles (EP) of blood plasma are extremely heterogeneous and of diverse origin. EP are found in all biological fluids such as blood, urine, saliva and breast milk and conditioned media after cultivation of cells of transferable cell lines in them. The EP sizes range from a dozen nanometers to 10 μm . Among the EP, exomeres (< 50 nm), exosomes (30–150 nm), ectosomes or falling microvesicles (100–1000 nm), apoptotic bodies (1 000–5 000 nm), migrasomes (500–3 000 nm), and large oncosomes (1 000–10 000 nm) can be distinguished. Among the above types of EP, it is customary to distinguish small EP (sEP), which includes exomeres and exosomes, and intermediate/large sized EP (m/IEP) – particles of all other subtypes. However, since the sizes may overlap, it is not enough to rely solely on their size to assign a particular EP to a particular subtype. It is necessary to take into account the features of the morphology of the EP, in particular the presence of an internal cavity, and, as a consequence, the presence of a bilayer lipid membrane, density and the presence or absence of certain proteins and lipids. EP biogenesis is also an essential factor.

It is known that cholesterol makes up a significant part of the lipids of exomeres. Depending on the source of intake, there are two main ways of cholesterol metabolism: exogenous (with food) and endogenous. Exogenous cholesterol is absorbed in the intestine as part of lipid micelles in a limited amount. Further, it reaches hepatocytes in the composition of chylomicrons, where it undergoes

esterification, or turns into bile acid salts. Biosynthesis of endogenous cholesterol from acetyl-CoA is carried out mainly in hepatocytes and in trace amounts in enterocytes of the small intestine. Part of the cholesterol is excreted with bile, and the other is esterified.

The aim of this work was to study exomeres and exosomes, to identify their common properties and features of exomeres, as well as to attempt to identify at least some metabolic processes in the cell and the body as a whole that lead to the formation of exomeres.

We have shown that 1) the exomeres are full-fledged extracellular particles, as they carry the tetraspanin markers CD9, CD63, and CD81; 2) the synthesis of exomeres is not associated with cell death; 3) exomeres cannot be associated with lipoproteins, as they do not carry biomarkers characteristic of lipoproteins, and vice versa; 4) cholesterol plays an essential role in the production of exomeres by cells, but does not affect the production of exosomes; 5) the concentration of exomeres in the body correlates with the concentration of cholesterol in plasma, but weakly correlates with the concentration of cholesterol in lipoproteins. This indicates that not all cholesterol in plasma is associated with lipoproteins, as it was thought until now.

Thus, exomeres play an essential role in cholesterol transport, and these effects are observed not only *in vitro*, but also *in vivo*.

Study of the Structure of Complexes of Myeloperoxidase, Ceruloplasmin, and α -Thrombin, Methods of Molecular Research and SANS

Ya.A. Zabrodskaya, V.V. Egorov, A.V. Shvetsov, N.D. Fedorova

Molecular and Radiation Biophysics Division of NRC "Kurchatov Institute" – PNPI

Myeloperoxidase (MPO) is a dimeric heme-containing enzyme of neutrophils and monocytes that is involved in innate immunity reactions. During the process of neutrophil degranulation, MPO is exposed, which leads to the formation of neutrophil extracellular traps and membranous tubulovesicular processes (or cytomeres). In the last decade, the specific binding of MPO to erythrocytes, platelets, neutrophils, endothelial cells, and a number of extracellular matrix components has been widely studied. The use of heparin as a soluble competitor significantly increased the release of MPO from the extracellular matrix and cell surface. MPO catalyzes the formation of hypochlorous acid (HOCl) and other reactive halogen species with cytotoxic properties.

The work is devoted to the study of the structural characteristics of the myeloperoxidase–ceruloplasmin–thrombin complex using the methods of

small-angle neutron scattering in combination with computer simulation (Fig.), as well as the method of surface plasmon resonance and solid-phase enzyme analysis. We have previously shown that the functioning of active myeloperoxidase during inflammation, despite the presence of an excess of ceruloplasmin in the blood, which suppresses its activity, is possible due to partial proteolysis of ceruloplasmin by thrombin. In this study, myeloperoxidase–ceruloplasmin–thrombin heterohexamer was produced *in vitro*. The construction of a full-atomic model of the heterohexamer *in silico*, taking into account the glycosylation of its constituent proteins, confirmed the absence of steric barriers for the formation of protein–protein contacts. It was shown that partial proteolysis of ceruloplasmin does not affect its ability to bind to myeloperoxidase, and a structural model of the heterohexamer was obtained by small-angle neutron scattering.

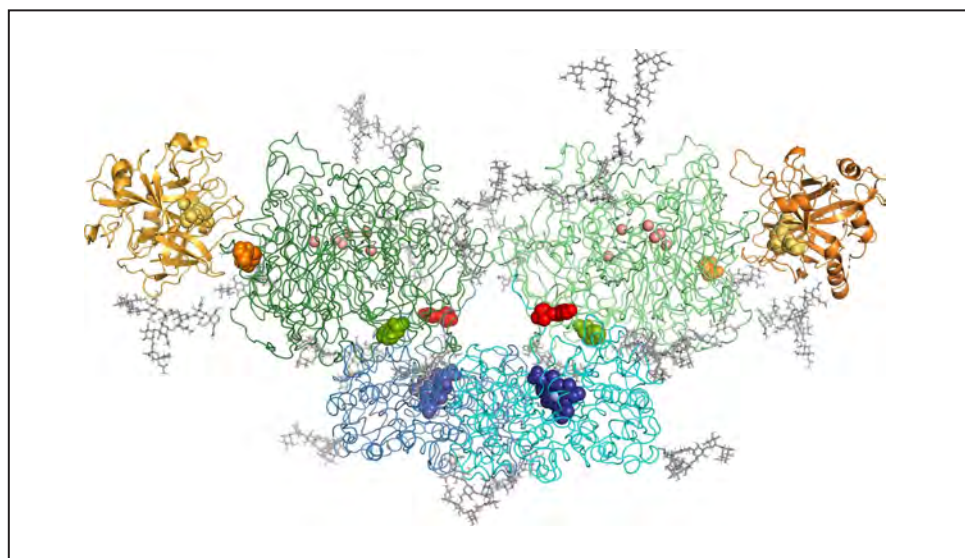

Structural model of the TRB-CP-MPO-MPO-CP-TRB complex obtained as a result of docking, taking into account glycosylation: MPO – blue; CP – green; TRB – gold; N-sugars – grey. Heme is shown as blue spheres in MPO molecules, iron atoms are represented as light blue spheres

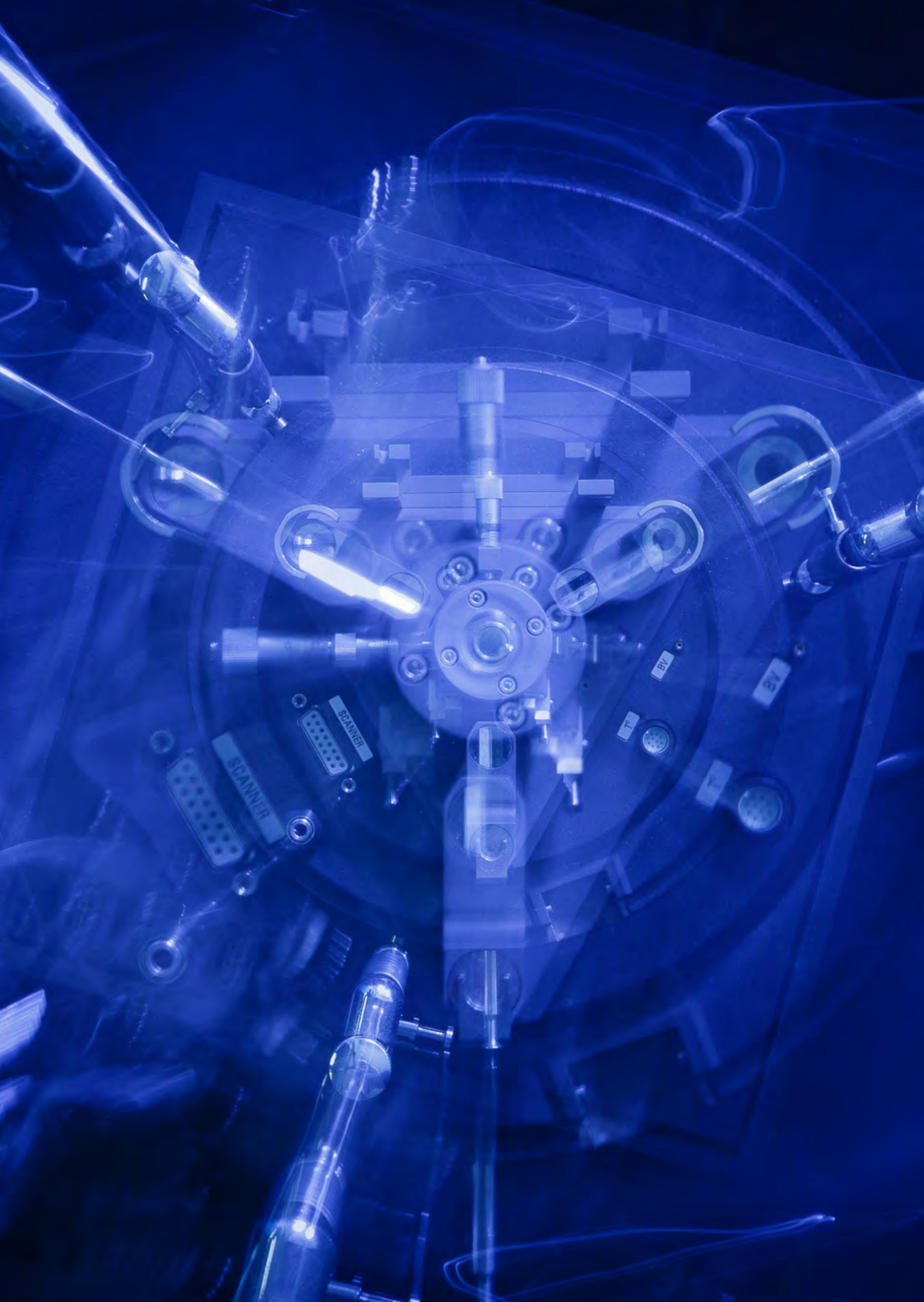

Nuclear Medicine (Isotope Production, Beam Therapy, Bio- and Nanotechnologies for Medical Purposes)

- 74 Experimental Confirmation of Proton Boron Capture Therapy in Cell Models

Experimental Confirmation of Proton Boron Capture Therapy in Cell Models

T.A. Shtam^{1,2,3}, V.S. Burdakov^{1,2}, A.V. Garina^{1,2,4}, L.A. Garaeva^{1,2,4}, N.H. Tran⁴,
A.V. Volnitskiy^{4,2}, E. Kuus^{4,5}, D.A. Amerkanov^{2,6}, F.A. Pack^{2,7}, G.I. Andreev⁵,
A.I. Lubinskiy⁵, K.A. Shabalin^{1,2}, N.A. Verlov^{1,2}, E.M. Ivanov⁶, V.F. Ezhov⁸,
D.V. Lebedev^{1,2}, A.L. Konevega^{1,2,4}

¹ Molecular and Radiation Biophysics Division of NRC “Kurchatov Institute” – PNPI

² NRC “Kurchatov Institute”

³ Institute of Cytology of RAS

⁴ Peter the Great Saint Petersburg Polytechnic University

⁵ Proton Therapy Center of Sergey Berezin Medical Institute

⁶ Advanced Development Division of NRC “Kurchatov Institute” – PNPI

⁷ Department of Medical Radiology of NRC “Kurchatov Institute” – PNPI

⁸ Neutron Research Division of NRC “Kurchatov Institute” – PNPI

The aim of this series of studies was to evaluate the sensitizing potential of boron-containing compounds under proton irradiation at the Bragg peak of cultured glioma cells. Proton therapy is currently used to treat many types of cancer. Protons rapidly lose energy in the last few millimeters of tissue penetration, resulting in a sharply localized absorbed dose peak called the Bragg peak. The use of binary technologies, in which the damaging effect of proton radiation is further enhanced by the preliminary selective accumulation of radiosensitizers in the target tissue, can significantly increase the effectiveness of radiation therapy methods. Proton boron capture therapy emerged from particle acceleration research to increase the biological effectiveness of proton therapy. It was assumed that the mechanism responsible for the dose increase is associated with the reactions of proton capture by the ¹¹B atom ($^{11}\text{B} + p \rightarrow 3\alpha + 8.7 \text{ MeV}$) (Fig.). There is some experimental evidence that the biological efficiency of protons is significantly higher for ¹¹B-containing prostate or breast cancer cells. The measured survival rates of tumor cells in proton boron capture experiments gave grounds for the conclusion that, if further data obtained are confirmed both *in vitro* and in preclinical studies, these results represent an important breakthrough in cancer therapy using accelerated proton beams.

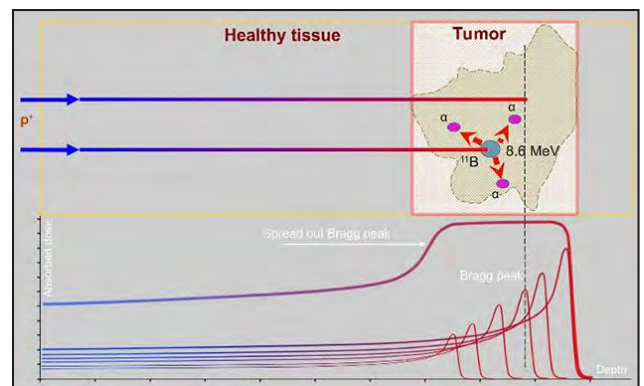

Schematic representation of proton boron capture therapy

Considering the inconsistency of literature data, as well as the paucity of experimental studies in this area, the purpose of the presented series of works was to identify the sensitizing effects of boron compounds during irradiation with protons in the Bragg peak. In other words, the main task of the work was to experimentally test the data presented in the work of Cirrone *et al.* on cell cultures, which, if confirmed, would open up prospects for approbation of proton boron capture therapy in animal models and clinical trials. In general, the work was carried out at the world level of research in this area.

In the first of the presented works, an attempt was made to find out whether the effect of increasing the lethality of tumor cells of gliomas contain-

ing ^{11}B will take place when irradiated with protons under the conditions of the Bragg peak. In the experiments, we used two tumor cell lines of gliomas, A172 and GI-Tr, obtained from independent sources, and as a control, non-tumor fibroblasts DF-2 of the eyelid skin of an adult donor, which is a commonly accepted set in such experimental works. Sodium tetraborate ($\text{Na}_2\text{B}_4\text{O}_7$) was used as a boron-containing preparation. Irradiation of cell cultures with protons was carried out at the CT-1000 synchrocyclotron of NRC “Kurchatov Institute” – PNPI, where a proton beam with an energy of 200 MeV was created with all settings for localizing the irradiated cells in the region of the Bragg peak. With special care, the concentration of sodium tetraborate was selected, because it turned out that all three cell lines are differently inactivated at different concentrations of the boron-containing compound. And the final useful finding turned out to be a parallel study of the lethality of selected cell lines both from the action of a proton beam and ^{60}Co γ -radiation in the presence of selected concentrations of ^{11}B . Unexpectedly, the sensitizing effect of sodium tetraborate was determined not only for protons, but also for γ -irradiation, which indicated not only the physical nature of the effect of boron on the viability of irradiated tumor cells, but also the specific biological effect exerted by the selected boron-containing drug. In general, the conducted experiments with sodium tetraborate left the question of the possibility and effectiveness of proton boron capture therapy open.

The second study is essentially a continuation and development of the first one. A distinctive feature of this article is a multiple increase in the amount of experimental data on the inactivation of already three tumor cell lines: A172 and

GI-Tr glioma cell lines; and Du145 prostate cancer cell line. An additional ^{11}B -containing preparation, sodium borocaptate ($\text{Na}_2\text{B}_{12}\text{H}_{11}\text{SH}$), containing three times more boron atoms in the molecule, was involved in the study. The range of concentrations of boron-containing preparations used also increased greatly (up to 160 or 250 ppm). During irradiation under the conditions of the Bragg peak, both the previously used 200 MeV protons and therapeutic protons with an energy of 89.7 MeV were used. Data on cell survival were recorded both by counting surviving clones and by using the metabolic MTT test. All results were subjected to thorough statistical processing. Nevertheless, even in this extended range of experiments, it was not possible to convincingly confirm the possibility of increasing the efficiency of ^{11}B -proton capture therapy for tumor diseases; rather the opposite.

We have shown that sodium borocaptate (BSH) provides only a slight increase in the effect of proton radiation on tumor cells *in vitro*.

The presented studies of the potential of various boron compounds to increase the effectiveness of proton therapy obviously claim to be original. Obviously, if the previously published data are confirmed and proton boron capture therapy is tested on animal models, it is possible to introduce this technology into medical practice, since the boron-containing preparation BSH is registered and used for boron neutron capture therapy. However, a number of theoretical works, as well as the presented results of experimental studies, do not confirm the sensitizing properties of ^{11}B during irradiation of tumor cells with protons at the Bragg peak. Nevertheless, such negative results also clearly make a significant contribution to both the scientific and practical aspects of the question of the potential of boron proton capture therapy.

1. Shtam T., Burdakov V., Garina A., Garaeva L., Tran N., Volnitskiy A., Kuus E., Amerkanov D., Pack F., Andreev G., Lubinskiy A., Shabalin K., Verlov N., Ivanov E., Ezhov V., Lebedev D., Konevega A. // Sci. Rep. 2023. V. 13. P. 1341.
2. Tran N.H., Shtam T.A., ..., Konevega A.L., Lebedev D.V. // Biomedicines. 2023. V. 11. P. 1727.



Nuclear Reactor and Accelerator Physics

- 78 Substantiation of Lifetime and Life Extension of the Experimental Channels of the PIK Reactor
- 79 Use of Burnable Absorbers in the PIK Reactor to Increase the Run Time
- 81 Adjustment of the Regulations Based on the Experience of Chemical Control of PIK Reactor Coolants from 2012 to 2021

Substantiation of Lifetime and Life Extension of the Experimental Channels of the PIK Reactor

A.E. Kirzhaev¹, V.I. Popov², R.M. Ramazanov², S.R. Friedmann¹

¹ Department of Reactor Physics and Technology of NRC “Kurchatov Institute” – PNPI

² NRC “Kurchatov Institute” – CRISM “Prometey”

The lifetime of experimental channels (ECs) from aluminum alloys of the PIK reactor PIK.32.000, PIK.33.000, PIK.37.000, PIK.38.000, PIK.56.000 and a central experimental channel (CEC) PIK.51.000 were substantiated before March, 31 and December, 31 2022, correspondingly. To extend the lifetime of ECs, a set of measures for non-destructive testing and technical inspections was carried out in 2022 in accordance with the developed program “Assessment of the technical position and residual life of the experimental channels of the PIK reactor”, No. 22-UE-PIK-19.00P. An inspection of the available places of the outer surfaces of EC PIK.33.000 and CEC PIK.51.000 using a video camera inside the heavy-water reflector tank was carried out. An inspection of the internal surface and ultrasonic thickness testing of the channels were made. Leakage tests of aluminum channels were carried out. The data of water-chemistry conditions control of the heavy-water reflector were obtained and analyzed.

Analysis and improved assessment of the current state of ECs made it possible to justify the lifetime of aluminum channels by at least six years until the end of 2024 in fulfilling the requirements of the water-chemistry conditions in the environment of the heavy-water reflector tank. The zero point of the lifetime is determined by the installation time of channels in the heavy-water reflector tank at the end of 2018 after cleaning from corrosion damage. It is accepted that the estimated growth rate of pittings is not more than 0.2 mm/year. It is two times higher than the maxi-

imum experimentally obtained estimate during corrosion tests. Determination of the residual lifetime of the enclosure according to the criterion of loss of strength was carried out on the channel PIK.56.000 with the minimum thickness of the wall.

The lifetime of the CEC is limited by the achievement of neutron fluence $3.3 \cdot 10^{21} \text{ cm}^{-2}$ ($E > 1 \text{ MeV}$) that roughly corresponds to the power output of the PIK reactor – 4 800 MW · day. The CEC is on the list of equipment that is inaccessible for inspection, so the extension of its lifetime is possible on the basis of testing of witness samples under the program “Inspection of witness samples of the PIK reactor during operation”, No. PM.240-1188. At the present time the program No. 240-1188 in terms of samples from zirconium alloy E-125 is being performed. The trial samples were loaded to the holes of the guided grid PIK.23.050, and their first unloading is scheduled when the reactor power output reaches ~ 610 MW · day.

Based on the results of an analysis of the obtained positive inspection results, the lifetime extension of the experimental channels of the PIK reactor was substantiated, and the technical decision agreed by the head design organization – JSC “NIKIET”, the leading materials science organization – NRC “Kurchatov Institute” – CRISM “Prometey” was issued. It allows to use: aluminum channels of the PIK reactor up to December, 31 2024; central experimental channel – up to neutron fluence $3.3 \cdot 10^{21} \text{ cm}^{-2}$ ($E > 1 \text{ MeV}$).

1. Substantiation of Lifetime of the Experimental Channels of the PIK Reactor of NRC “Kurchatov Institute” – PNPI. Technical Certificate of NRC “Kurchatov Institute” – CRISM “Prometey” No. 220930-01-S. 2022.

2. On the Lifetime of the Experimental Channels of the PIK Reactor. Technical Decision No. 22 UE-PIK-35.00TR of 28.10.2022.

Use of Burnable Absorbers in the PIK Reactor to Increase the Run Time

N.S. Zhihareva¹, K.A. Konoplev², M.S. Onegin¹

¹ *Theoretical Physics Division of NRC “Kurchatov Institute” – PNPI*

² *Department of Reactor Physics and Technology of NRC “Kurchatov Institute” – PNPI*

The PIK high-flux reactor is now being put into operation for purposes of scientific research at NRC “Kurchatov Institute” – PNPI. To increase the run time, it was decided to develop a new core design with the fuel assemblies (FA) being replaced by fuel assemblies containing burnable absorbers. Firstly, steel displacers are to be replaced by burnable absorbers based on Gd_2O_3 . Other changes include a 20% larger uranium load, replacing of steel FA casings by zirconium ones and a different fuel profiling scheme in the cassettes. All these measures significantly increase the initial reactivity margin up to 13% neglecting the gadolinium poisoning at the start of a run.

A special feature of the PIK reactor is the relatively low weight of the regulator devices, so that the total efficiency of all control units does not exceed 7% in terms of reactivity. The production of ^{135}Xe , reaching 4%, makes a negative contribution to reactivity at the start of reactor operation. Thus, with the initial reactivity margin of about 7%, only about 2–3% remain after xenon poisoning for further poisoning and burnup of the fuel. This effects short reactor runs ~ 7 days. The xenon poisoning can be compensated by using burnable absorbers, but in the core they must burn out in a time comparable to xenon production, i. e., the neutron capture cross section must be comparable to that of ^{135}Xe . The gadolinium isotopes ^{155}Gd and ^{157}Gd , which are presented in native mixture, have the maximum capture cross section for thermal neutrons. ^{157}Gd has the maximum neutron capture cross section, equal to about 0.25 Mb. This is 10 times less than for ^{135}Xe , so the gadolinium burn-up rate in the core will be significantly less than the xenon production rate and will not make it

possible to compensate the decrease of the initial reactivity margin in the reactor due to the poisoning.

There is a central water cavity containing a central experimental channel (CEC) in the PIK reactor. The thermal neutron flux density in it is more than 10 times higher than the neutron flux density in the core. As a result, the gadolinium burns out in it in a time comparable to the xenon production rate in the core, so that the effect of the initial reactivity margin reducing on account of the production of xenon can be significantly diminished.

In addition, gadolinium burnable absorbers in the form of a rod, half-cylinder, or cruciform shape coinciding with the shape of the fuel rods are planned to be used in the fuel assemblies. Rod-shaped burnable absorbers (RBA) in the form of a half-cylinder replace steel displacers in the starting design of fuel assemblies, having the same shape and arranged along the perimeter, cruciform burnable absorbers replace part of the fuel rods. By starting fresh fuel loading it is possible to use cylindrical boron-containing zirconium rods instead of some of the fuel rods. Significantly diminishing the reactivity margin at the beginning of a cycle, they make it possible to reach steady-state operation of the reactor with refueling.

To increase gadolinium burnup in the PIK reactor, it is proposed to use RBAs with low gadolinium content, similar to those used in transport reactors. As in transport reactors, it is proposed to use two types of gadolinium-based RBAs – with low gadolinium content for replacing displacers in FA and with high content of gadolinium in cruciform-shaped RBAs instead of the fuel rods. This allows, on the one hand, significantly diminishing the initial jump in the reactor reactivity due to its

poisoning and, on the other hand, it will provide a longer operation time at nominal power without refueling.

Research has shown that placing in the CEC of the PIK reactor with a high flux of thermal neutrons of the gadolinium burnable absorber allows significantly reducing a jump in the reactor reactivity due to xenon poisoning at the beginning of the reactor cycle. Another effective means of reducing it at the beginning of the cycle is using RBAs with a low gadolinium content instead of displacers in fuel assemblies. In total, these two measures reduce the step change of reactivity during the first 5 days of the reactor cycle at nominal power from 4.68 up to 1.82% (Fig.).

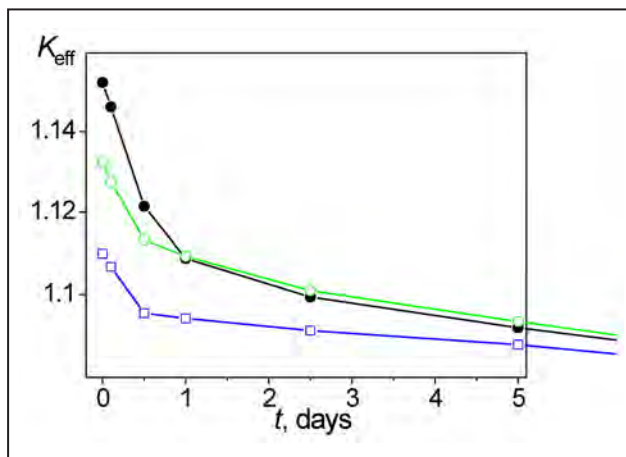

To reduce the reactivity margin at the reactor start-up it is possible to use cruciform RBAs with nominal or increased content of gadolinium in them. Calculations show that gadolinium almost completely burns out in the core for 45 days. At the same time, the losses from the replacement of 132 fuel rods by RBAs at the run end are equal to $\sim 0.5\%$ in terms of reactivity, or 3.8% of the initial reactivity margin.

The reactivity due to rapid burnout of absorbers after pressing the emergency protection button at run start was analyzed. It was shown that the reactor remains nuclear-safe in this case.

Variation of the neutron multiplication factor during the first 5 days of reactor operation at nominal power without burnable absorbers in the core (●), with a burnable absorber in the central experimental channel (○), with burnable absorber in the central experimental channel and displacers in fuel assemblies (□)

Adjustment of the Regulations Based on the Experience of Chemical Control of PIK Reactor Coolants from 2012 to 2021

T.V. Voronina, E.S. Vinogradova

Nuclear Facility Complex Operation Department of NRC "Kurchatov Institute" – PNPI

The PIK reactor plant includes about 20 water systems, including systems important for reactor safety and requiring the chemical control (CC) of coolants. It is necessary to organize laboratory control of coolant samples at a proper level and thoroughly substantiate the norms for each coolant.

The experience of operation and CC of PIK reactor water systems for 2012–2021 made it possible to justify changes that had to be introduced to the existing regulation for the CC of water coolants and process discharges of the PIK reactor (No. 19RK-047.00 R). As a result, a new CC regulation (No. 22RK-027.00 R) was developed and approved. First, the correction of CC concerned coolants of the primary circuit, the heavy-water reflector (HWR), the liquid regulation (LR) circuit, the main secondary circuit (MSC), and the emergency secondary circuit (ESC), including the list of monitored parameters and norms for them.

1. The discrepancy between the standards set for the coolant water at inlet and at outlet of reactor has been eliminated. In order to control the process of the coolant hydrogenation it was proposed to determine the concentrations of dissolved oxygen and hydrogen peroxide, and to consider the possibility of creating a continuous monitoring system of dissolved gases on the basis of domestic analyzers. The maximum allowable value of the specific electrical conductivity increased to 4 $\mu\text{S}/\text{cm}$. The established earlier norm (2 $\mu\text{S}/\text{cm}$) does not correspond to the established range at pH = 5.0–7.0. At pH = 5.0 the calculated specific electrical conductivity of perfectly pure water is 3.6 $\mu\text{S}/\text{cm}$ only due to H^+ and OH^- ions.

When the reactor operates at a power, radiolysis processes take place in the coolant. In the presence of oxygen and nitrogen in the water, this leads to the formation of nitrates (nitric acid). If there is an excess of dissolved hydrogen (during hydrogenation), ammonia is formed. Therefore, it is necessary to control the pH-value and the concentration of nitrate and ammonium.

2. The experience of CC of MSC and ESC has shown that coolant reanalysis is required only after technical operations aimed at improving the quality of water in the system (partial or complete replacement of water in the system, the introduction of reagents to correct the pH, etc.). The large volume of the coolant in these circuits does not allow the chemical parameters to change rapidly, there is a high inertness of the processes, daily sample analysis is uninformative. Specific conductivity, pH and total hardness of the MSC coolant exceeded the norms during the whole control period. This was because 99% of the system piping is made of carbon steel (steel 20). In fact, the main secondary circuits of PIK reactor are analogous to the secondary circuit of power reactors. Alkaline water-chemical regime is optimal for such schemes. Then the specific electric conductivity is not regulated, the pH range is up to 10.0. Until the MSC water treatment unit is launched, it was suggested to use such norms.

3. To control the processes of radiolysis and corrosion in the heavy-water circuits of the HWR and LR, it is necessary to determine the concentration of dissolved oxygen and deuterium, as well as the concentration of nitrates (in the coolant of LR) and transparency.

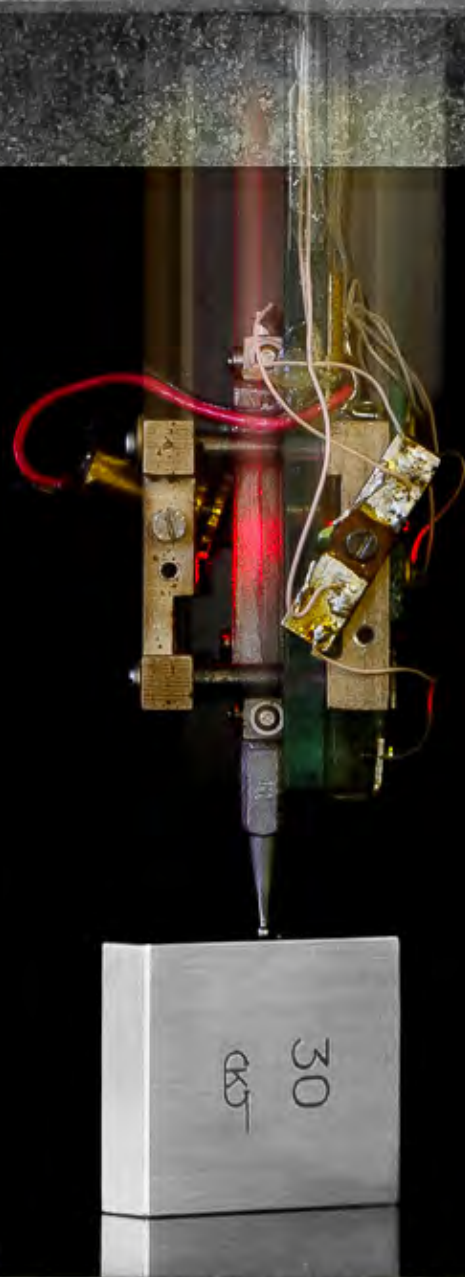
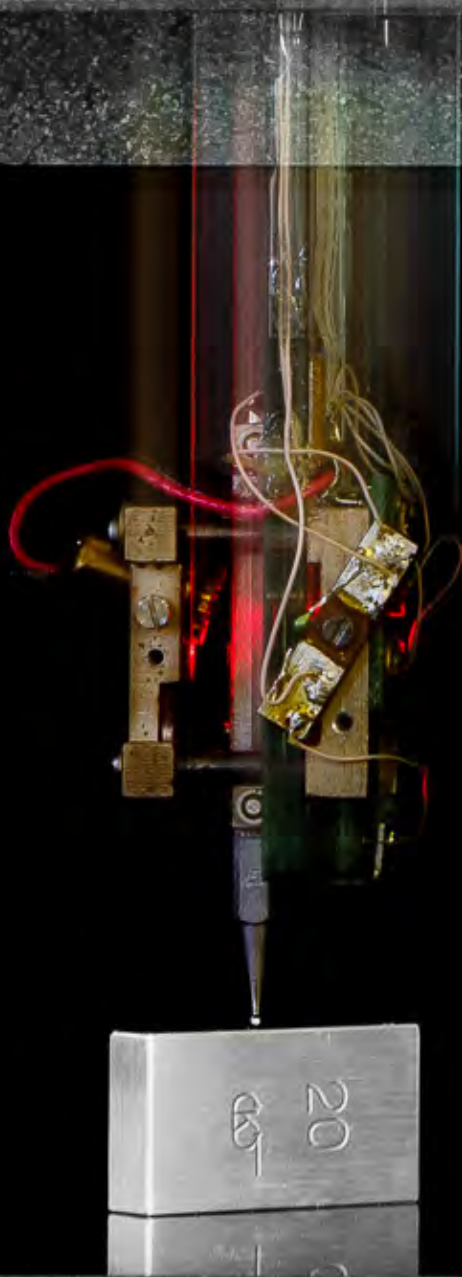

Applied Research and Developments

- 84** EXFOR–NSR PDF Database: a System for Nuclear Knowledge Preservation and Data Curation
- 85** Synthesis and Characterization of Carbon Cryogel
- 86** Compositional Membranes with Nanodiamonds for Hydrogen Fuel Cells
- 87** Steam Reforming as a Method of Disposal of Liquid Radioactive Waste
- 88** Holographic Nanolength Meter with Plain Bearing

EXFOR–NSR PDF Database: a System for Nuclear Knowledge Preservation and Data Curation

A.A. Rodionov, G.I. Shulyak

Neutron Research Division of NRC “Kurchatov Institute” – PNPI

Current needs of nuclear science and technology include complete, well-documented, and easily verifiable nuclear data. Experimental nuclear reaction data (EXFOR) and Nuclear Science References (NSR) databases contain compilations based on primary (journals) and secondary (conference proceedings, theses, preprints, etc.) publications, and data received from authors via private communications. The secondary library materials and private communications often represent a bottleneck for nuclear data verification, compilation, evaluation, and dissemination activities. To address this issue, bibliographic materials were scanned into PDF (portable document format) files and uploaded in a relational database.

The full PDF publication files were saved in a relational database. This unique collection of nuclear

data compilations and supporting publications opens up many possibilities for machine learning applications.

Web interfaces for authorized and public access to the EXFOR–NCR nuclear publications database were implemented at the US National Nuclear Data Center (<https://www.nndc.bnl.gov>) and the IAEA Nuclear Data Section (<https://www.nds.iaea.org>). The proposed system complements the main nuclear libraries and focuses on procedures for collecting and evaluating nuclear data. In the Figure, the proposed system is illustrated by an example of neutron spectra data retrieval (EXFOR) and original publication text (PDF) by bibliographic reference (NSR).

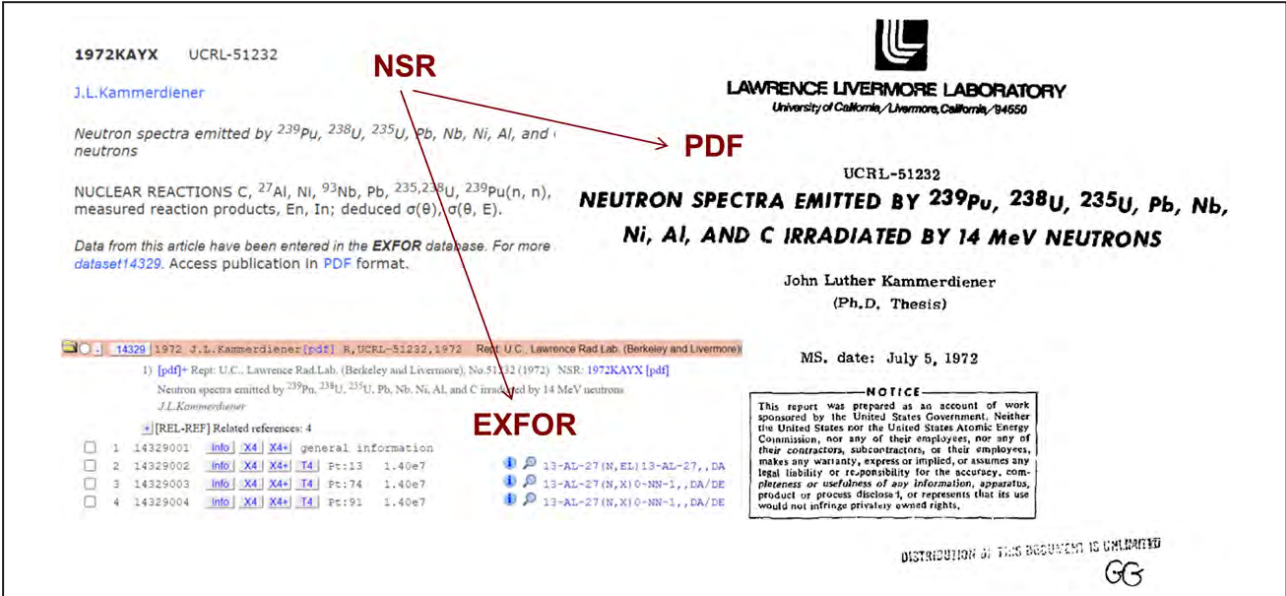

The screenshot displays a web interface for nuclear data retrieval. It features a search bar at the top left with the text "1972KAYX UCRL-51232" and "J.L. Kammerdiener". Below the search bar, there is a list of related references under the heading "[REL-REF] Related references: 4". The selected reference is highlighted in blue and includes the following information:

NSR (Nuclear Science Reference) entry:

1972KAYX UCRL-51232
 J.L. Kammerdiener
 Neutron spectra emitted by ^{239}Pu , ^{238}U , ^{235}U , Pb, Nb, Ni, Al, and C
 neutrons
 NUCLEAR REACTIONS C, ^{27}Al , Ni, ^{93}Nb , Pb, $^{235,238}\text{U}$, $^{239}\text{Pu}(n, n)$,
 measured reaction products, En, In; deduced $\sigma(\theta)$, $\sigma(\theta, E)$.
 Data from this article have been entered in the EXFOR database. For more
 dataset14329. Access publication in PDF format.

EXFOR (Experimental Nuclear Reaction Data) entry:

1) [pdf] Rept. U.C. Lawrence Rad. Lab. (Berkeley and Livermore), No. 51132 (1972) NSR: 1972KAYX [pdf]
 Neutron spectra emitted by ^{239}Pu , ^{238}U , ^{235}U , Pb, Nb, Ni, Al, and C irradiated by 14 MeV neutrons
 J.L. Kammerdiener

PDF (Publication) entry:

LAWRENCE LIVERMORE LABORATORY
 University of California, Livermore, California, 94650
 UCRL-51232
**NEUTRON SPECTRA EMITTED BY ^{239}Pu , ^{238}U , ^{235}U , Pb, Nb,
 Ni, Al, AND C IRRADIATED BY 14 MeV NEUTRONS**
 John Luther Kammerdiener
 (Ph.D. Thesis)
 MS. date: July 5, 1972

NOTICE

This report was prepared as an account of work sponsored by the United States Government. Neither the United States nor the United States Atomic Energy Commission, nor any of their employees, nor any of their contractors, subcontractors, or their employees, makes any warranty, express or implied, or assumes any legal liability or responsibility for the accuracy, completeness or usefulness of any information, apparatus, product or process disclosed, or represents that its use would not infringe privately owned rights.

DISTRIBUTION OF THIS DOCUMENT IS UNLIMITED

An example of neutron spectrum data retrieval from J.L. Kammerdiener’s thesis: bibliographic reference (NSR); nuclear data (EXFOR); publication (PDF)

Synthesis and Characterization of Carbon Cryogel

G.P. Kopitsa¹, B. Matović², S. Butulija², T. Minović Arsić², I. Cvijović-Alagić²,
Yu.E. Gorshkova³, S.Yu. Kottsov⁴

¹ Neutron Research Division of NRC “Kurchatov Institute” – PNPI

² Vinča Institute of Nuclear Sciences – National Institute of the Republic of Serbia, Serbia

³ Frank Laboratory of Neutron of the Joint Institute for Nuclear Research

⁴ Kurnakov Institute of General and Inorganic Chemistry of RAS

Cryogels are highly porous solid-phase materials obtained by freeze drying of gels and their subsequent heat treatment in an inert atmosphere. A special class of cryogels are carbon cryogels (CCs), which have not only a large specific surface area and porosity, but also high electrical conductivity and thermomechanical stability. These properties make it possible to use carbon cryogels as components of catalytic systems; ultralight structural materials; sorbents; supercapacitors, electrodes in fuel cells based on proton-exchange membranes, and as anodes in lithium-ion batteries.

A CC obtained by a three-stage synthesis, which includes the formation of a gel from a mixture of resorcinol-formaldehyde resins, followed by freeze drying and pyrolysis in nitrogen at 800 °C, was studied by complementary methods: X-ray diffraction, Raman spectroscopy, Fourier-transform infrared spectroscopy, differential thermal and thermogravimetric analyses, scanning electron microscopy, helium pycnometry, low-temperature nitrogen adsorption, small-angle X-ray scattering (SAXS), and small-angle neutron scattering (SANS). SAXS allows obtaining more complete information about the organization of the structure of porous materials, since X-ray scattering occurs at the phase boundary “solid phase–pores”. At the same time, using this method, it is impossible to separate the contribution of scattering from open and closed pores to the total scattering intensity. To solve this problem, it is necessary to use the technique of contrast variation in SANS.

Since the amplitude densities of the scattering lengths ρ of carbon ($\approx 7 \cdot 10^{10} \text{ cm}^{-2}$) and heavy

water D_2O ($\approx 6.34 \cdot 10^{10} \text{ cm}^{-2}$) are very close, the method of changing the contrast can be applied in SANS experiments. Based on this, the use of D_2O as an adsorbate makes it possible to achieve almost zero contrast ($\langle \rho^2 \rangle \approx 0$) between the solid phase of the carbon cryogel and the system of open pores filled with D_2O . In this case, SANS will occur at the interface between the solid phase of CC and closed pores and will be determined by the contrast:

$$\langle \rho^2 \rangle = (\rho_{\text{CC}(\text{D}_2\text{O})} - \rho_{\text{close pore}})^2 \cdot (\varphi_{\text{CC}} + \varphi_{\text{D}_2\text{O}}) \cdot \varphi_{\text{close pore}},$$

where φ_{CC} is the volume of solid phase of the cryogel; $\varphi_{\text{D}_2\text{O}} = \varphi_{\text{open pore}}$ is the volume of open pores filled with D_2O and $\varphi_{\text{close pore}}$ is the volume of closed pores, respectively, where $\varphi_{\text{CC}} + \varphi_{\text{D}_2\text{O}(\text{open pore})} + \varphi_{\text{close pore}} = 1$.

A comprehensive study showed that the synthesized carbon cryogel is an amorphous material with high open porosity ($\approx 82.5\%$) and a three-modal distribution of open pores by size $dV(r)$ with maxima $r_{\rho 1} \approx 3 \text{ nm}$, $r_{\rho 2} \approx 15 \text{ nm}$, and $r_{\rho 3} \approx 30 \text{ nm}$, respectively, and a low content of micropores ($r \leq 2 \text{ nm}$). The use of SANS with contrast variation technique and D_2O adsorption by carbon cryogel made it possible to separately study the structure of open and closed pores, as well as to estimate both the volume fraction of closed pores ($\varphi_{\text{close pore}} \approx 1\%$) and the total porosity ($\varphi_{\text{total}} \approx 83.5\%$) of the obtained CC.

We have demonstrated the possibility of using the contrast variation method in SANS to study the porous structure of materials based on (cryogels, aerogels, pyrogels, etc.).

Compositional Membranes with Nanodiamonds for Hydrogen Fuel Cells

Yu.V. Kulvelis¹, V.T. Lebedev¹, O.N. Primachenko², A.V. Shvidchenko³,
N.V. Glebova³, N.P. Yevlampieva⁴

¹ Neutron Research Division of NRC “Kurchatov Institute” – PNPI

² Institute of Macromolecular Compounds of RAS

³ Ioffe Institute of RAS

⁴ Saint Petersburg University

We have studied the structure and properties of composite membranes based on an Aquivion[®]-type copolymer with additives of detonation nano-diamond (DND), having a positive ζ -potential. Previously, it was shown that this type of nanodiamonds, having hydrogen atoms on the surface, most successfully modifies the process of proton conductivity in moistened membranes due to a rather uniform distribution of diamond particles in the polymer matrix.

According to the small-angle neutron scattering data on membrane samples, the ionomer peak at $q \sim 2 \text{ nm}^{-1}$ is preserved in the presence of diamonds, which characterizes the saving of the structure of conducting channels in the polymer matrix (Fig. 1). It has been shown, together with scanning electron microscopy data (Fig. 2), that the positive charge of diamond nanoparticles provides their rather uniform distribution in the polymer matrix, in the form of small clusters up to 200–300 nm in size, even at a high diamond content (up to 5 wt. %). The composite membrane has optimal conducting and mechanical properties at 0.5 wt. % DND.

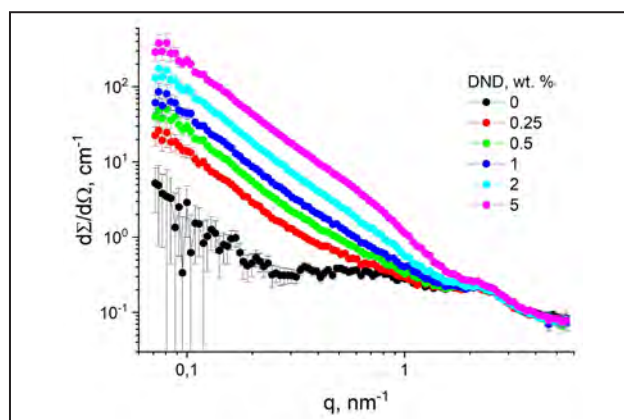

Fig. 1. Small-angle neutron scattering on Aquivion[®]-type membranes with DND content 0–5 wt. %

The electrochemical tests of membranes carried out in membrane-electrode assemblies also showed the best characteristics at 0.5 wt. % DND, significantly exceeding the parameters of the unmodified membrane (without diamonds). The use of the obtained membranes for operation in hydrogen fuel cells with operating temperatures up to 120 °C is shown to be promising.

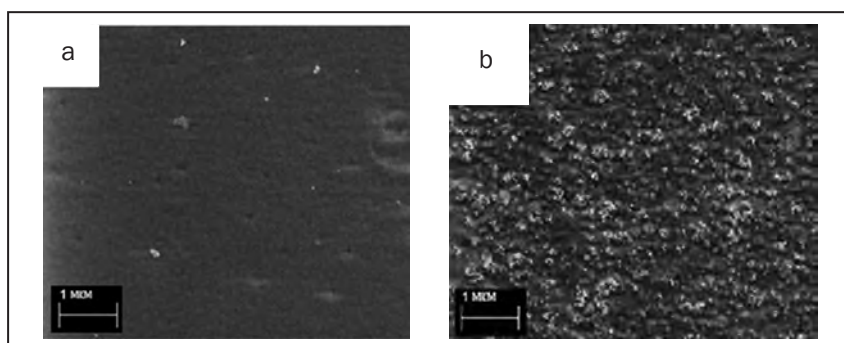

Fig. 2. Scanning electron microscopy images of Aquivion[®]-type membranes with DND: a – 0% DND (without nanodiamonds); b – 5 wt. % DND

Steam Reforming as a Method of Disposal of Liquid Radioactive Waste

A.V. Basharichev¹, I.S. Okunev¹, V.Ya. Sirotyuk¹, V.A. Golikov³

¹ Scientific Center for Integrated Security of NRC “Kurchatov Institute” – PNPI

² Neutron Research Division of NRC “Kurchatov Institute” – PNPI

³ LLC “Fuel Ecological Company”

In accordance with the Federal Law of July 11, 2011 No. 190-FZ “On the management of radioactive waste and on amendments to certain legislative acts of the Russian Federation”, accumulated radioactive waste classified as disposed radioactive waste must be extracted, processed, conditioned, and buried.

By 2030, 83 000 spent fuel assemblies will have to be removed and 3 000 t of spent nuclear fuel will be reprocessed.

It is planned to decommission 82 nuclear and radiation-hazardous facilities, mothball seven industrial uranium-graphite reactors, and rehabilitate 4.3 million m² of territory.

NRC “Kurchatov Institute” – PNPI together with LLC “Fuel Ecological Company” explores the possibility of using liquid radioactive waste recycling technology, as well as an ion exchange resin using glassy carbon for the sorption of radioactive contamination and the possibility of condensation on lignin.

Using the steam reforming method, liquid radioactive waste is transferred to a carbon sorbent formed as a result of the hydrogen decomposition of lignin.

Glassy carbon and carbon ash with radioactivity can be disposed of using conventional methods of glass transition, cementation and bituminization with an increase in the strength of the compound due to the specific structure of the carbon additive.

Distinctive features of the proposed technology are the use of microwave energy to produce superheated steam, the creation of drying, carbonization and conversion zones in the reactor with a uniform temperature distribution over the cross section.

As a result of research on the disposal of liquid toxic waste using superheated high-temperature steam, a solid carbonaceous residue containing metals, including precious ones, was obtained.

This technology has shown its effectiveness in the disposal of waste of hazard classes 1–3, so it can also be used in the disposal of liquid radioactive waste, after additional research and clarification of application features.

Tests have been carried out on the utilization of ion-exchange resins with superheated steam, resulting in a reduction in the mass of processed samples. Research has been carried out on the use of ash carbon residue (glassy carbon) for the disposal of contaminated radioactive waste as a sorbent and assessment of the sorption capacity of glassy carbon of individual radionuclides from aqueous solutions with a positive result in reducing the specific activity of water.

Further development and, in the future, industrial application of the proposed technology will significantly reduce the formation of hazardous waste at landfills and sludge storage facilities, reducing the cost of processing hazardous waste.

Holographic Nanolength Meter with Plain Bearing

B.G. Turukhano, N. Turukhano, S.N. Khanov, O.G. Ermolenko

Advanced Development Division of NRC "Kurchatov Institute" – PNPI

Humanity is currently attempting to exploit nanoscale objects. An important result of such processes is the creation of the Russian holographic length meter with plain bearing (HLMPB) with a record resolution of 10 nm and higher.

A plain bearing (PB, Fig. 1) is an assembly that interacts between two moving parts, one of which is stationary. The bearing is mounted with its sliding element (SE, Fig. 2) on the surface of one of the units and will move along it, replicating its characteristics with the least distortion, transmitting this motion to the other unit.

The HLMPB enables increased accuracy of movement and allows it to move on any plane and in any trajectory. It serves as an intermediate link between two nodes of the same or different mechanisms, transmitting the movement of one node relative to the other with the least amount of loss and distortion. This is ensured by the factors identified in the device: 1) reduction of dynamic errors; 2) reduced influence of dust particles and temperature on the bearing units due to the possibility of using materials with a low thermal expansion coefficient; 3) increased resistance to corrosion, as the bearing units are made of high hardness materials; 4) possibility of non-lubricated operation due to design features of the SE containing gro-

oves, as well as due to the use of SE materials with micro-grooves; 5) no conductivity with selection of appropriate materials; 6) possibility of plane movement in any trajectory.

This combination of attributes in the HLMPB allows for: 1) increase the accuracy of the mechanical unit's movement on the bearing surface; 2) reduce the influence of temperature; 3) operate without lubrication; 4) be corrosion resistant; 5) eliminate electrical conductivity; 6) to move it flat on any trajectory.

Prior to operation, a PB is assembled from the assemblies shown in Fig. 1a, b including platform 4, ball 5 (rigidly fixed with upper hemisphere 8 to platform 4 by bonding), SE 1, thread 12 and housing 10. The bearing is then installed in an external device where it will further function between two units of this device, one of which is stationary (Fig. 3, unit 3) and rigidly connected to the PB, the other is stationary (see Fig. 3, unit 2). The SE 1 of the PB is mounted with the plane A containing grooves 11 (see Fig. 1b) on the supporting surface 2 (see Fig. 3), on which it will move (slide), coming into contact with it. When moving on the bearing surface, the SE is positioned in such a way that it can then be moved at an angle of 45° in the di-

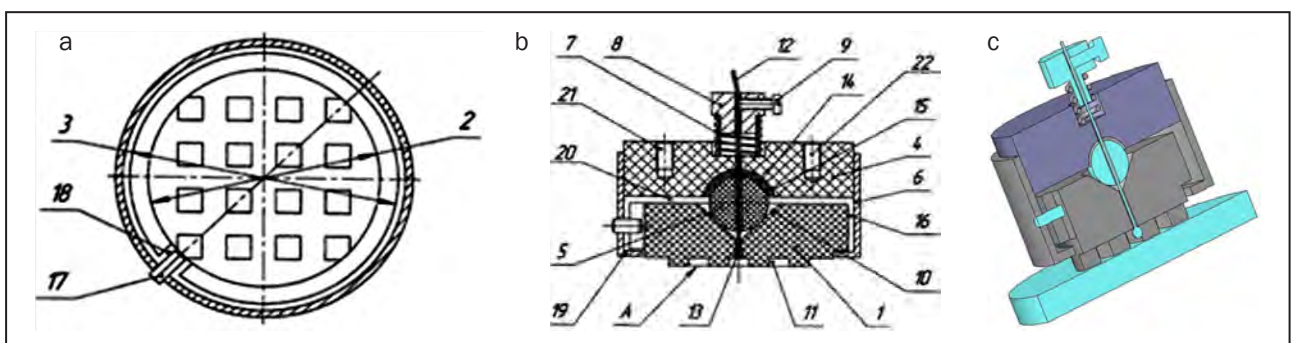

Fig. 1. Holographic plain bearing. General view (a–c)

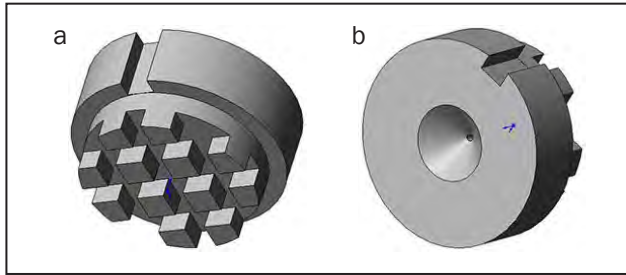

Fig. 2. Sliding element. View from: a – the supporting side surface; b – the platform side

rection of the slot 18. For this purpose, the axis of slot 18 must coincide with the direction of movement. An air cushion is formed under each pad on the A–SE side, which prevents the sliding element from sticking to the supporting surface, and the SE has the additional possibility to move on this given supporting surface.

In order to determine the error introduced by the sliding bearing during its practical application in the HLMPB system, a high-precision digital holographic longimeter DG-30 with 0.01 μm resolu-

tion was used (see Fig. 1). The study determined the flatness of the plate surface 2 (see Fig. 3), which was moved during the test on the bearing surface of the gabrodiabase platform. At that deviation from flatness of gabrodiabase platform surface on which investigated slab 2 was mounted ($\pm 0.02 \mu\text{m}/300 \text{ mm}$) and an error of holographic long meter DG-30 ($0.01 \mu\text{m}/30 \text{ mm}$) in total must be less than an expected error value of the PB including its important parameter – run-out.

During the experiment the holographic longimeter together with the PB is immovable relative to the investigated moving plate located on a gabrodiabase platform. At the same time the DG-30 holographic longimeter allows to trace the deviations from the flatness of the surface of the investigated slab. It can be seen in Fig. 4 that the error of all elements used in the experiment: length gauge DG-30 with PB, investigated slab and gabrodiabase platform was less than $\pm 0.045 \mu\text{m}$ (90 nm) at the length of 180 mm.

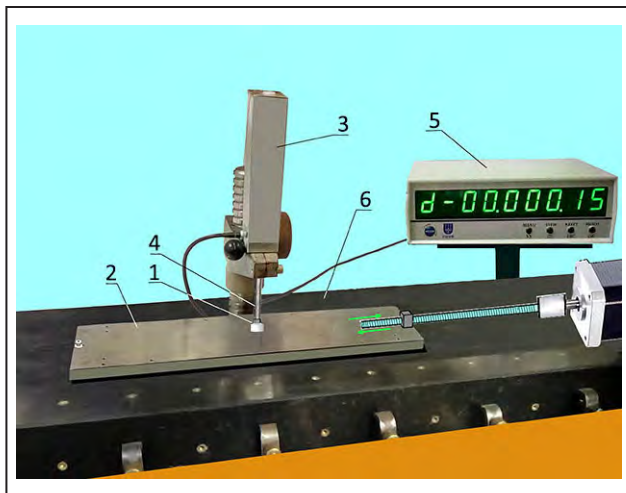

Fig. 3. Holographic longimeter with plain bearing in operation: 1 – sliding bearing; 2 – metal plate under study; 3 – holographic DG-30 longimeter; 4 – longimeter rod; 5 – longimeter control unit; 6 – surface of the gabrodiabase base plate

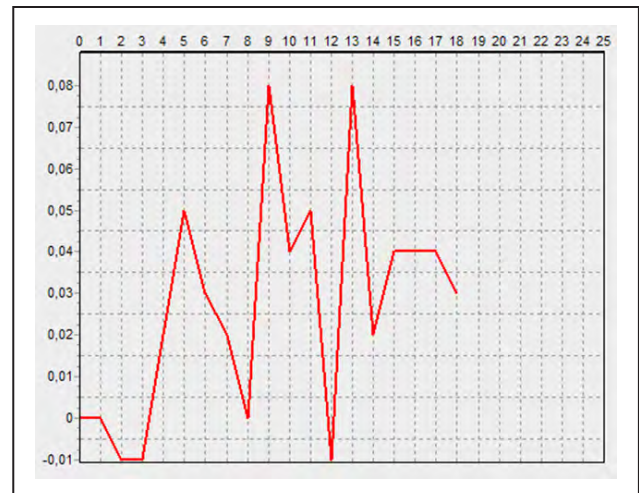
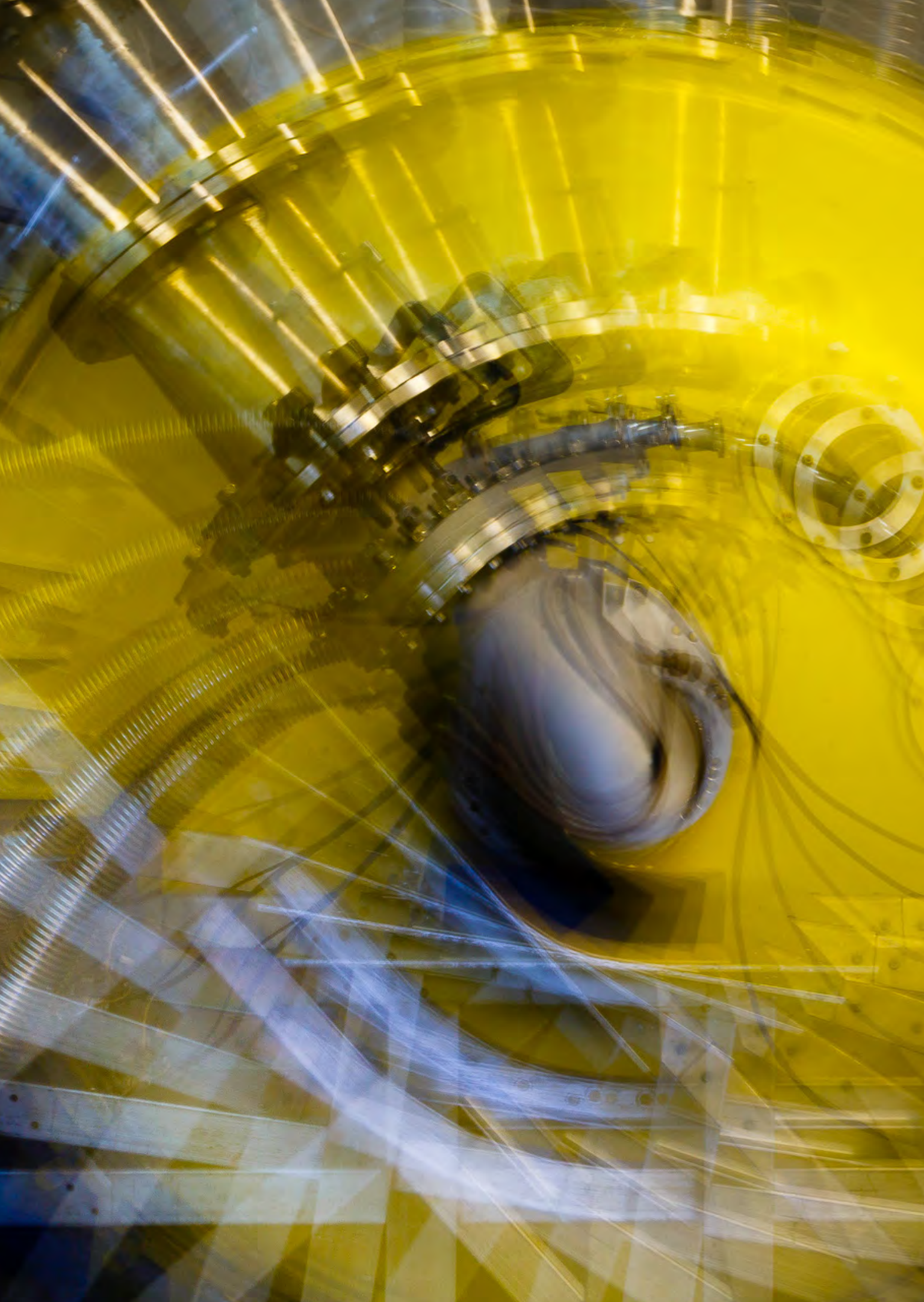

Fig. 4. Graph of scanning a gabrodiabase plate using a self-aligning, self-cleaning, clutchless, sliding bearing



Basic Installations

- 92 Progress of the PIK Reactor Power Start-Up Program in 2022
- 94 PIK Research Reactor Put into Megawatt-Power Operation
- 95 PIK Research Reactor Put into Megawatt-Power Operation.
First Experimental Results
- 97 Estimating the Neutron Flux in a Spallation Experiment
on the PNPI Synchrotron
- 98 Coordinate Detectors for High Particle Rates Based
on Multiwire Gaseous Electron Multiplier
- 99 The Readout Electronics Concept Development of the Tracking
System of the SPD Experiment at the NICA Collider

Progress of the PIK Reactor Power Start-Up Program in 2022

A.S. Zakharov¹, A.S. Poltavskii², S.R. Friedmann¹

¹ Department of Reactor Physics and Technology of NRC “Kurchatov Institute” – PNPI

² Department of Nuclear and Radiation Safety of NRC “Kurchatov Institute” – PNPI

In 2022, the phased commissioning of the PIK reactor was continued, taking into account the reliable operation of systems important for safety at a power of up to 10 MW.

The personnel of the organizations participating in the reactor power start-up: NRC “Kurchatov Institute” (head scientific organization), JSC “Dollezhal Research and Development Institute of Power Engineering” (head design organization), OOO “Spetsproekt” (head project organization), NRC “Kurchatov Institute” – PNPI (operating organization), performed substages 3-10 of the first stage of the PIK reactor power start-up program in the power range up to 7 MW. The work was carried out in accordance with the terms of the license of the Federal Service for Environmental, Technological and Nuclear Supervision No. GN-03-108-3378 of 06.07.2017 and amendments No. 1–5, authorizing the operation of the PIK reactor at a power up to 10 MW.

During the implementation of substages 3-10 of the PIK reactor power start-up program:

- Planned critical experiments, neutron-physics and hydrodynamic measurements were carried out at given power levels up to 10 MW, confirming the design characteristics of the PIK reactor;
- Three trial samples with metal witness samples were loaded to the holes of the guided grid PIK.23.050;
- The calibration of the regulatory bodies of the reactor control and protection system was checked – shim-safety rods and hafnium control rods;
- Calibration test of neutron flux control equipment ASUZ-03R based on the results of irradiation of neutron activation detectors in the inclined and vertical experimental channels in subranges of 100 W and 100 kW was made;

- Experiments were carried out to measure the hydrodynamic effect of reactivity in accordance with the stages of the work program No. 21RK-002.00Pr;

- A sequential power ascension of the reactor up to levels of 200, 400, 800, 2 000, 5 000, 7 000 kW (Fig.) was performed with verification of the operation of reactor systems and experimental equipment of research stations on extracted neutron beam;

- The necessary tests and physical measurements were carried out when the reactor reached megawatt-power levels;

- Experimental work was carried out at scientific stations.

In addition, the radiation situation in the premises of the PIK research facility and at the scientific and technical site of the Institute was within normal limits.

The total power generation was about 46 000 kW · h (1.92 MW · day).

Computational support for the experiments was provided by a set of certified computer programs, including MCNP, MCU-5, etc. used to substantiate safety during the operation of the PIK reactor.

The normal operation of the ASUZ-03R system was confirmed, taking into account the identified features at low levels of reactor power. The system provides protection of the reactor even at low power at extremely low neutron flux densities. It has been established that the hydrodynamic effect of reactivity remains stable at all stages of increasing the reactor power. It has been confirmed that the radiation monitoring system of the PIK reactor makes it possible to reliably and quickly record the radiation situation in the pre-

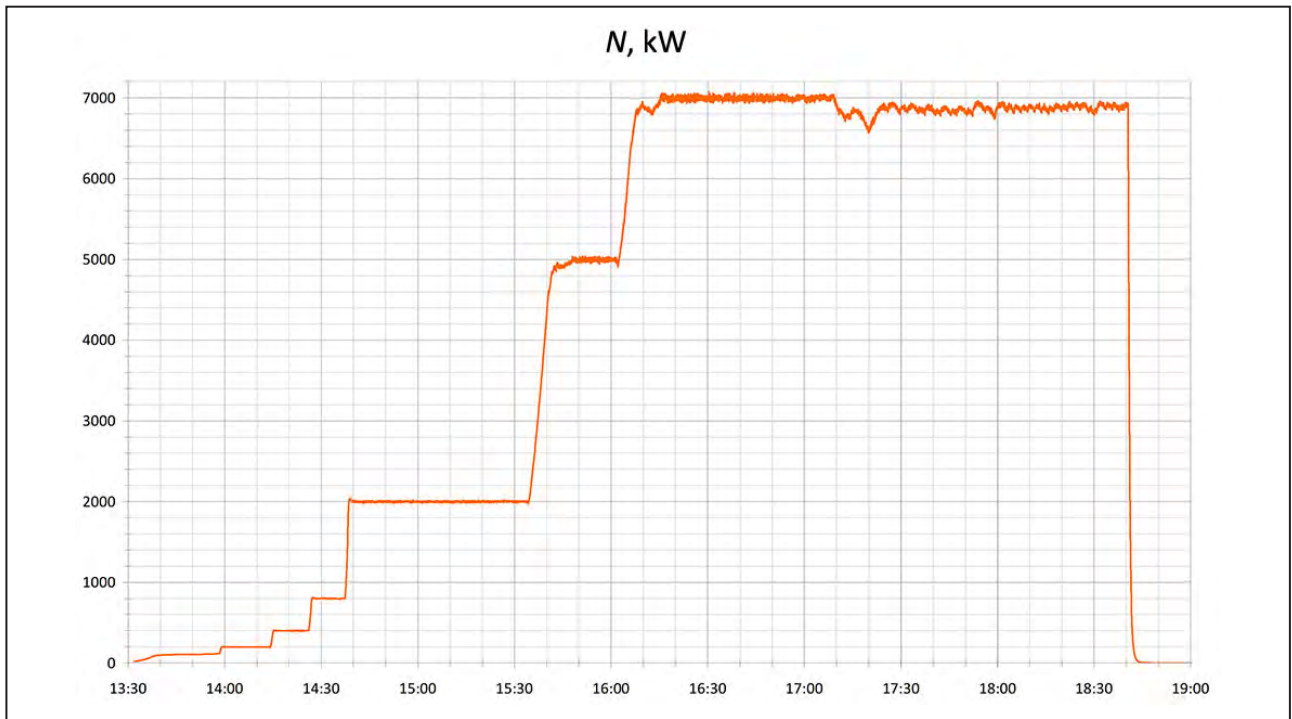

Graph of the reactor ramp-up to 7 MW power level

mises of the reactor facility PIK. The obtained results of physical measurements correspond to the expected effects and parameters given in the documents justifying the safety of the PIK reactor.

The carried out tests confirmed the compliance of the systems with the design requirements and the ability of these systems to provide the operational safety limits. Experiments at research stations have been carried out in full.

Based on the test results an analysis of the operation of the affected equipment was carried out. Conclusions and recommendations were summarized and the immediate tasks for preparing for the next stages of the power start-up were determined.

PIK Research Reactor Put into Megawatt-Power Operation

V.V. Voronin¹, A.V. Gartvik¹, S.V. Grigoriev¹, M.V. Dyachkov², D.A. Ipatov¹, V.A. Matveev², S.V. Gavrilov¹, V.V. Tarnavich¹, V.G. Syromyatnikov², A.O. Polyushkin¹, K.A. Pshenichnyi¹, V.A. Ulyanov², V.G. Zinoviev¹

¹ Neutron Research Division of NRC “Kurchatov Institute” – PNPI

² Engineering Center “Neutron Technologies” of NRC “Kurchatov Institute” – PNPI

The high-flux research reactor PIK has reached megawatt power. The reactor is in a phased commissioning mode and in March 2022 achieved a power of 7 MW. The reactor is designed to operate on extracted beams, on which the first five neutron stations were built and the first test experiments were carried out. The absolute value of the thermal neutron flux at the output of the HEC-10 channel of the PIK reactor was measured using two independent methods. The integral neutron intensity on the HEC-10 channel were measured depending on time during the reactor ramp-up to 7 MW power. To record the neutron intensity, three detectors were simultaneously used: a low-efficiency detector based on ²³⁵U (transmission monitor), a ³He detector SNM-12 located

in tangential geometry relative to the beam, and an additional ³He detector SNM-18 installed on the direct beam. The spectra of neutron beams were measured on two neutron extraction channels.

The time dependence of neutron intensity for various detectors is presented in the Figure. The inset shows the dependence of the integral neutron intensity on the reactor power. According to the low-efficiency transmission monitor, the neutron intensity is linear with increasing reactor power and will reach a flux of the order of $10^9 \text{ cm}^{-2} \cdot \text{s}^{-1}$ at the exit from the HEC-10 channel at a reactor power of 100 MW. Monitors based on ³He show an obvious miscalculation when increasing reactor power.

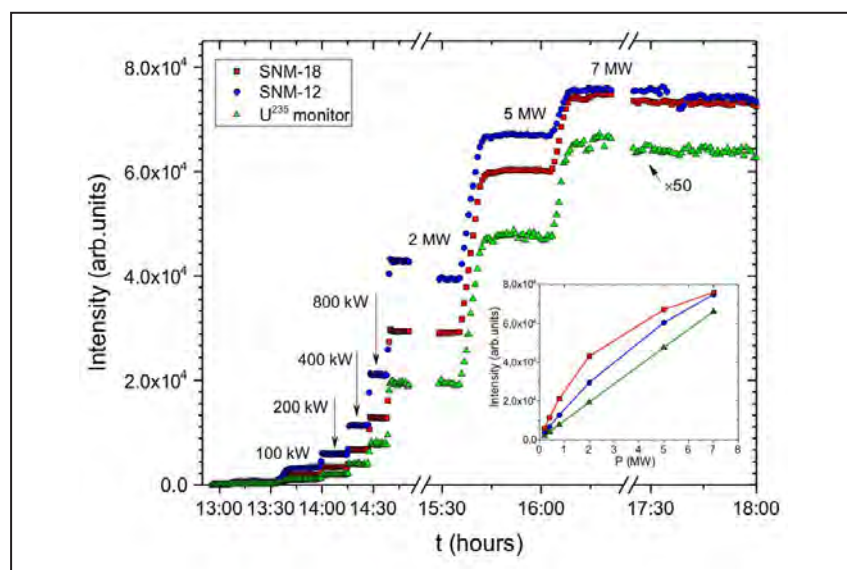

Time dependence of intensity during the reactor ramp-up to 7 MW power. *Insert* – dependence of the integral neutron intensity in the extracted channel on the reactor power

PIK Research Reactor Put into Megawatt-Power Operation. First Experimental Results

V.V. Voronin¹, S.V. Gavrilov¹, A.V. Gartvik¹, M.V. Diachkov², D.A. Ipatov¹,
N.A. Kovalenko¹, V.A. Matveev², V.G. Syromyatnikov², V.V. Tarnavich¹, V.A. Ulyanov²

¹ Neutron Research Division of NRC “Kurchatov Institute” – PNPI

² Engineering Center “Neutron Technologies” of NRC “Kurchatov Institute” – PNPI

In 2021, the PIK reactor was put into energy operation mode of the stage aimed at reaching the power up to 10 MW. In March 2022, the ramp-up of reactor power up to 7 MW was completed, which confirmed the high qualification of personnel and demonstrated stable and reliable operation of the reactor and process systems.

Preparations are underway for the transition from a launching core to an operational set of fuel assemblies providing a satisfactory reactor cycle of about 25 days between fuel reloads. The concept of the new fuel for the PIK reactor is based on the use of commercially available fuel elements (fuel rods) of the SM reactor design with increased ²³⁵U loading, the use of a burnable absorber and modernization of the fuel assembly design. Currently, preparations are underway to sign a contract with the “TVEL” enterprises of the State Corporation “Rosatom” for the supply of the first batch of new fuel in 2023.

Simultaneously with an increase in the reactor power, a suite of scientific instruments is being developed.

The use of a neutron radiation source is most efficient if the highly efficient neutron beams, ejected from the high-flux reactor, are delivered without loss to ultramodern experimental instruments, enabling the most advanced research in all above fields. Therefore, both components (i. e. high performance of the neutron source itself and the state-of-the-art level of the instrument suite) are of equal importance for successful implementation of scientific programs of the International Center for Neutron Research at the PIK reactor. Thus, one of the basic principles of the overall concept of experimental stations development – the improvement of the instrument suite – should

go hand in hand with the improvement of the neutron source.

The provision of the PIK reactor with a set of modern equipment is carried out within the project “Creation of the Instrument Suite of the PIK Reactor Facility” (2019–2024). In December 2020, five research stations of the PIK reactor facility were put into operation. They are:

- Test neutron reflectometer (TNR), designed for testing neutron polarizing and non-polarizing mirrors of neutron guides and other neutron-optical devices, including those intended for the reactor facility;
- TEX-3 texture diffractometer for the texture diffraction applications, including studies of the texture of structural and technical materials;
- Polarized-neutron diffractometer (PND) for studies of magnetic ordering features in crystal structures;
- NERO-2 polarized-neutron reflectometer for studies of the surface structures, interfaces, thin films, and multilayer structures of both magnetic and nonmagnetic materials;
- “T-Spectrum” test neutron spectrometer for recording the neutron spectrum with a time-of-flight method at the output of the experimental channels and neutron guides of the reactor.

The experiments at five stations were performed at the stage of reactor transition to the energy operation mode, at which the thermal power of 10 MW had to be reached. The following methodical experiments were carried out: measurement of the absolute neutron flux on horizontal experimental channel No. 10, study of the characteristics of the four-mode neutron-beam former (polarizer) on the TNR reflectometer, analysis of the characteristics of the neutron-optical

former (polarizer) on the NERO-2 reflectometer, etc.

In order to ramp up the reactor power to 10 MW and put into operation the five research neutron stations listed above, a list of neutron-physical calculations was prepared to substantiate biological shielding for compliance with the requirements of Principal Sanitary Radiation Safety Rules (OSRP 99/2010). Experimental stations were placed on horizontal channels of HEC-2, 3, 8, 9, 10. For each of them, neutron flux densities were calculated at the outer slice of the dismountable shielding of the PIK reactor, which were further used as input data for simulation of biological shielding for neutron stations.

To determine the design and material composition of the biological shielding for each neutron instrument, a mathematical model was developed

and the spatial distributions of the equivalent dose rate (EDR) level were calculated.

To assess the effectiveness of the developed biological shielding, radiation background measurements were made in the experimental hall of horizontal channels when the reactor was operating at 7 MW. The measurement results for some points are presented in the Table. The calculated value of total EDR (neutrons and γ -quanta) for the considered power is 4.2 $\mu\text{Sv/h}$ on the shielding surface.

For all cases considered, except for the PND station, the measured EDR from neutrons and γ -quanta do not exceed the calculated values obtained at the simulation stage. A minor exceeding of total EDR of the PND shielding unit might be due to lack of fit during installation, which can be solved by compensating measures in the future.

Table. Results of radiation background measurements at the stations in the experimental hall of horizontal channels

Station	Values		Measurement point
	γ , $\mu\text{Sv/h}$	$\gamma + n$, $\mu\text{Sv/h}$	
PND	2.5	6.4	Frontally on the housing of the PND shielding unit
"T-Spectrum"	0.8	1.8	Frontally on the housing of the "T-Spectrum" shielding unit. 30 cm from the beam axis
NERO-2	1.6	1.8	On the left side of the housing of the NERO-2 shielding unit
TNR	3.2	3.8	On the left side of the housing of the TNR shielding unit
TEX-3	1.5	1.7	On the left side of the housing of the TEX-3 shielding unit

1. Kovalchuk M.V., Voronin V.V., Gavrilov S.V., Gartvik A.V., Diachkov M.V., Ipatov D.A., Matveev V.A., Tarnavich V.V., Ulyanov V.A. // Kristallografiya. 2022. V. 67. No. 5. P. 785–794.
2. Voronin V.V., Gartvik A.V., Gavrilov S.V., Grigoriev S.V., Diachkov M.V., Ipatov D.A., Matveev V.A., Tarnavich V.V., Syromyatnikov V.G., Polushkin A.O., Pshenichnyi K.A., Ulyanov V.A., Zinoviev V.G. // Neutron News. 2022. V. 33. Iss. 4. P. 13–16.
3. Diachkov M.V., Matveev V.A., Syromyatnikov V.G., Tarnavich V.V., Ulyanov V.A. First Neutron Measurements at Reflectometers TNR and NERO-2 // Neutron News. GNNW-2023-0001 to Be Published.

Estimating the Neutron Flux in a Spallation Experiment on the PNPI Synchrotron

K.V. Ershov¹, I.E. Alekseev², S.E. Belov²

¹ Neutron Research Division of NRC “Kurchatov Institute” – PNPI

² Khlopin Radium Institute

The experiment was carried out on an internal lead target of a synchrocyclotron of the PNPI, to which a proton beam with an energy of 1 GeV was periodically directed. The duration of the proton pulse is 10 ns with a repetition rate of no more than 50 Hz. The intensity of the proton beam was $3 \cdot 10^{11}$ protons per pulse ($1.5 \cdot 10^{13} \text{ s}^{-1}$). The average neutron multiplicity in the lead splitting reaction reaches ~ 20 , so this source provides $3 \cdot 10^{14}$ neutrons per second in all directions.

Several types of moderators were used for the experiment, but the simplest – a set of rectangular 24-liter canisters placed directly under the target-turned out to be the most convenient and effective. The canisters were tall enough to occupy almost all of the space under the chamber. The canister was positioned in front of the target to reduce the proton flux passing through the monitors, which were made of annealed stainless foil 25 μm thick and attached to tanks with adhesive tape in the same position relative to the canister.

The PHiTs neutron transport program was used to calculate the neutron flux and determine the activities of our samples. Using results from calculations, we estimated that five canisters with light water must be installed to obtain a flow of thermal neutrons with an admixture of high-energy (non-thermal) neutrons of no more than 1%. The activity of foils with areas of 0.5 mm^2 must be from several dozen to several hundred Bq.

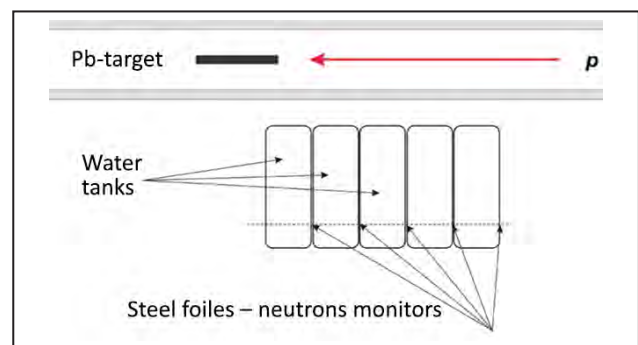

Scheme of the experiment

The γ -spectra of the neutron-activated foil were measured in the experiment. Although neutrons have energies ranging from 0.025 eV to 1 GeV and a large number of reactions are possible, the most likely were (n, γ) reactions with the formation of ^{99m}Tc and ^{51}Cr . The cross sections of these reactions depend on the neutron energy, which makes it possible to estimate the neutron spectrum by target activation. Modeling the geometry of the experiment in the PHiTs package, the result was a neutron flux on the sample $10^8 \text{ sm}^{-2} \cdot \text{s}^{-1}$ farthest from the target with an admixture of high-energy neutrons of no more than 1%.

The main conclusion of the experiment: by changing the moderator configuration, neutron fluxes with any energy distributions, both existing in reactors and “new” ones, can be obtained to create stands and conduct experiments on transmutation.

Coordinate Detectors for High Particle Rates Based on Multiwire Gaseous Electron Multiplier

A.P. Kashchuk¹, V.G. Baev², O.V. Levitskaya¹, S.A. Movchan³

¹ Advanced Development Division of NRC “Kurchatov Institute” – PNPI

² Institute of Power Engineering of NAS of Belarus, the Republic of Belarus

³ Joint Institute for Nuclear Research

Electrical fields, some architectures and characteristics of the new coordinate detectors based on the multiwire gaseous electron multiplier are presented in the study (Fig. a, b). Compared to the micropattern GEM detector, one obtains particle coordinates directly from wires at a very low material budget using Al–Mg wires and practically without the hydrogen-containing “organics”, which is crucial in the construction of neutron detectors. In this technical solution, an avalanche charge multiplication occurs in between wires resulting in a three orders of magnitude higher rate capability as well

as a submillimeter spatial resolution compared to a classical multiwire proportional chamber. Primary electrons are transported from drift to multiplication region at 100% efficiency if $s \approx \pi d$, while at $h \approx s$ the operational voltage decreases and the robustness of the device increases. In addition, at small h supporting wire spacers are easily introduced using a well-known technology based on photolithography and film photoresist etching in order to realize high planarity and to get a monolithic construction similar to the micropattern Micromegas detector.

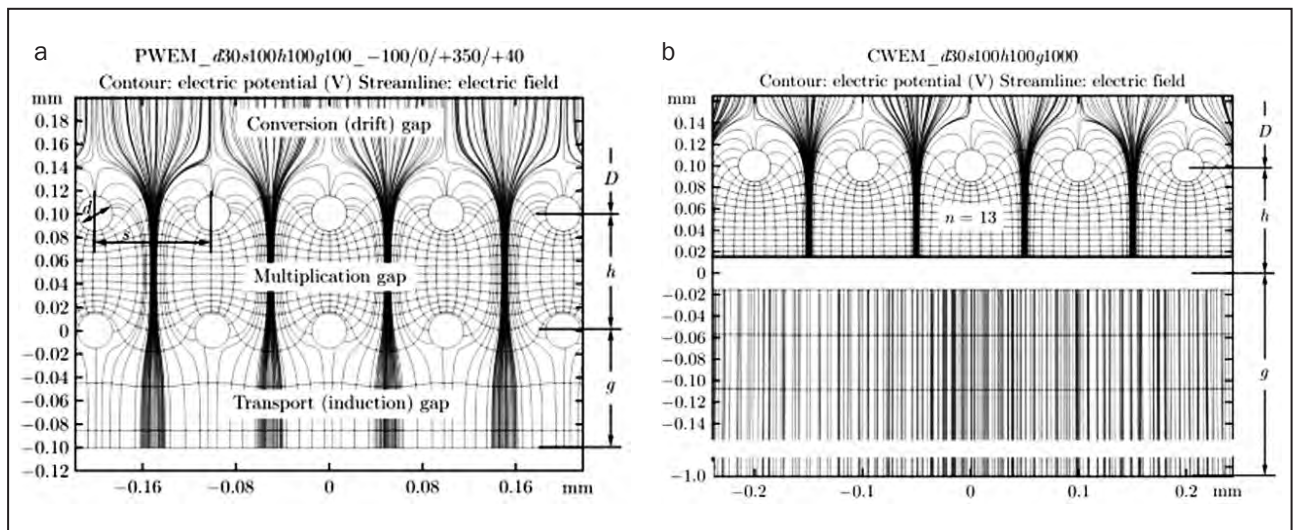

Electrical field lines and equipotentials shown in a plain which is perpendicular to electrodes of the multiwire gaseous electron multiplier with parallel wires (a) and orthogonal ones (b) for wires at $d = 30 \mu\text{m}$, $s = 100 \mu\text{m}$, $h = 100 \mu\text{m}$

1. Kashchuk A.P., Baev V.G., Levitskaya O.V., Movchan S.A. // Part. Nucl. Lett. 2022. V. 19. No. 4. P. 259–270.

2. Kashchuk A.P., Baev V.G., Levitskaya O.V., Movchan S.A. // Phys. Part. Nucl. Lett. 2022. V. 19. No. 4. P. 353–361.

The Readout Electronics Concept Development of the Tracking System of the SPD Experiment at the NICA Collider

V.T. Kim, E.V. Kuznetsova, S.G. Barsov, S.A. Bulanova, A.V. Zelenov,
V.P. Maleev, S.G. Nasybulin, D.E. Sosnov, O.L. Fedin

High Energy Physics Division of NRC “Kurchatov Institute” – PNPI,
SPD Collaboration

The Spin Physics Detector (SPD) experiment is part of the NICA megascience project, which currently involves about 300 scientists and engineers from 12 countries. The SPD aims to study strong interactions in polarized and unpolarized proton–proton and deuteron–deuteron collisions. The spin structure of protons and light nuclei and their 3D arton distributions will be studied as well. The SPD Conceptual Design Report was approved in 2021, and at the end of 2022 the SPD Technical Design Report was presented.

The NRC “Kurchatov Institute” – PNPI group is involved in the development of the tracking system, the technology of the tracking system straw manufacturing, the tracking system software, the physics of multiparton interactions and exotic multiquark resonances.

In 2022, NRC “Kurchatov Institute” – PNPI together with the Joint Institute for Nuclear Research participated in the development of the SPD tracking system readout electronics concept. To determine the requirements for readout electronics, three test beams were carried out at the SPS beam in the European Organization for Nuclear Research. Prototypes of the tracking system with several types of application specific integrated circuits (ASICs): VMM3a, VMM3, and Tiger – were used (Fig.).

The analysis of the collected data is processing at the moment. Very preliminary results of the tracking system readout electronics requirements were discussed with ASICs developers. Based on the processed data, realistic track parameterizations will be obtained. Further, using the software being developed by the NRC “Kurchatov Institute” – PNPI and Joint Institute for Nuclear Research groups, a GARFIELD based simulation of the SPD tracking system response will be developed.

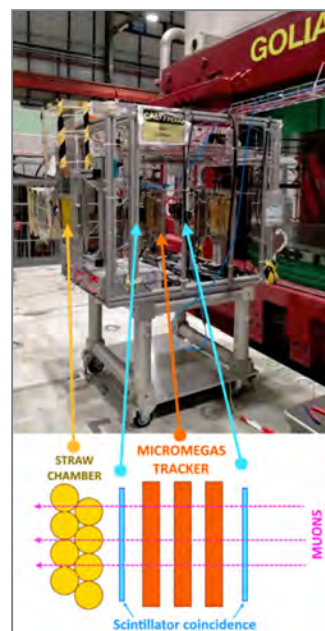

The SPD tracking system readout electronics concept with several types of ASICs at the SPS beam in European Organization for Nuclear Research



Scientific and Organizational Activities

- 102** Full-Time Personnel
- 105** Quantitative Characteristics of Scientific
and Educational Activities
- 110** Awards. Prizes
- 115** Scientific Events
- 120** Science News

Full-Time Personnel



For the first time, a scientist of NRC “Kurchatov Institute” – PNPI was awarded the honorary rank “Professor of the Russian Academy of Sciences”. Victor Germanovich Ryabov, a leading researcher of the HEPD, has become a professor of the Russian Academy of Sciences. Honorary academic rank awarded by the Presidium of RAS for scientific achievements of national or international level, as well as for active participation in the implementation of the main tasks and functions of the Academy, was conferred on him by the decision of RAS in May 2022.

Victor Ryabov has been working in the Laboratory of Relativistic Nuclear Physics of the HEPD since 1996.

His research interests include – experimental study of the mechanisms of light hadron production in collisions of heavy ultrarelativistic nuclei and study of the properties of subnuclear matter at extremely high baryonic densities and temperatures, design and construction of detectors for modern experimental facilities.

Since 1998, V.G. Ryabov has been a member of the PHENIX international collaboration at RHIC (BNL, USA), since 2010 – a member of the ALICE Collaboration at the LHC collider (CERN, Switzerland), and since 2018 a member of the MPD Collaboration at the NICA collider (JINR, Dubna).

V.G. Ryabov has made a great contribution to the development of original techniques for experimental data analysis, allowing to measure the properties of hadrons and photons (yields, angular distributions, etc.) under conditions of unprecedentedly high particle multiplicities achieved in collisions of heavy relativistic nuclei at the NICA, RHIC, and LHC colliders.

The rank of RAS Professor was introduced in 2015. The rank is awarded to Russian scientists not older than 50 years of age who carry out research or scientific-educational activities in various fields of knowledge and are not members of RAS. In total, 715 Russian scientists hold the rank “Professor of the Russian Academy of Sciences”. Until now, there were no representatives of NRC “Kurchatov Institute” – PNPI on the list.

Staff number

Professional qualification groups of positions	2020	2021	2022
Total not including part-time workers	1 987	1 970	1 878
Researchers, total	473	462	405
<i>Of which holding the position of</i>			
head	66	60	57
chief researcher	9	9	9
leading researcher	44	44	38
senior researcher	146	140	126
researcher	83	83	58
junior researcher	59	53	51
other researchers	66	73	66
<i>With a science degree</i>			
Doctor of Sciences	62	59	53
Candidate of Sciences	215	203	177
<i>With an academic rank</i>			
Academician	-	-	-
Corresponding Member	2	1	1
Professor	8	6	5
Docent	80	74	65

Information on scientific experience of NRC “Kurchatov Institute” – PNPI researchers

Position	Total	Including with the experience		
		less than 5 years	more than 5 years	more than 10 years
Heads of laboratories and departments	57	-	6	51
Chief researchers	9	-	-	9
Leading researchers	38	1	1	36
Senior researchers	126	3	9	114
Researchers	58	4	14	40
Junior researchers	51	26	12	13

Information on age distribution of NRC “Kurchatov Institute” – PNPI researchers

Professional qualification groups of positions	Age, years old					
	20–29	30–39	40–49	50–59	60 and older	mean age
Researchers, total	71	84	44	45	161	51
<i>With a science degree</i>						
Doctor of Sciences	–	–	6	9	38	75
Candidate of Sciences	1	33	26	26	91	58
<i>W/o science degree</i>	70	51	12	10	32	39
<i>With an Academic rank</i>						
Academician	–	–	–	–	–	–
Corresponding Member	–	–	–	–	1	77
Professor	–	–	–	–	5	83
Docent	–	–	–	4	61	73

The number and average age of researchers of NRC “Kurchatov Institute” – PNPI by position

Position	2020		2021		2022	
	Number	Mean age	Number	Mean age	Number	Mean age
Chief researcher	9	83	9	83	9	78
Leading researcher	44	68	44	68	38	67
Senior researcher	146	62	146	62	126	61
Researcher	83	50	83	50	58	49
Junior researcher	59	32	59	32	51	33
Heads	66	62	66	62	57	61
Other researchers	66	27	66	27	66	28

Structure and staffing for five years

Category of staff	2018	2019	2020	2021	2022
Scientific workers	489.2	435.5	450.2	430.4	423.3
Scientific and engineering staff	251.8	290.7	296.05	299.4	275.4
Office and management personnel	1 181.4	1 253.1	1 290.15	1 318.2	1 346.6
Junior service staff	32.5	32.5	31.5	31.5	31.5
Total	1 954.9	2 011.8	2 067.9	2 079.5	2 076.8

Quantitative Characteristics of Scientific and Educational Activities

NRC “Kurchatov Institute” – PNPI has completed all events and achieved all target indicators intended for 2022, owing to, in particular, the state assignment implementation subsidies for 2022 and the planning period of 2023 and 2024.

In 2022, the employees of NRC “Kurchatov Institute” – PNPI were the authors and co-authors of 604 papers including 383 publications indexed in Web of Science database and associated with NRC “Kurchatov Institute” – PNPI, which constitutes 63.4% of the total number of articles published.

Dynamic pattern of the number of publications affiliated with NRC “Kurchatov Institute” – PNPI for five years

Year	Total number of publications / publications including those indexed in Web of Science database
2018	689/507
2019	714/465
2020	674/473
2021	650/446
2022	604/383

Dynamic of participation in scientific events for five years

Year	Number of facts of participation of employees in exhibition activities, conferences, forums, and other similar events
2018	420
2019	422
2020	387
2021	417
2022	472

Number of international and Russian patents, whose holder is NRC “Kurchatov Institute” – PNPI obtained in 2022 depending on the title of protection type

Objects of patent law by title of protection type			
Patent for invention	Utility patent	Certificates of registration of computer software	Total
3	3	16	22

Dynamic pattern of titles of protections whose right holder is NRC “Kurchatov Institute” – PNPI for five years

Type of title of protection	2018	2019	2020	2021	2022
Patents for invention	7	10	5	7	3
Utility patents	4	2	8	1	3
Certificates of registration of computer software	25	12	13	19	16
Database certificates	1	-	-	-	-
Registered know-how	3	-	-	-	-
Total	40	24	26	27	22

In 2022, the scientific research of Institute’s employees was financed by RFBR (8 grants) and RSF (18 grants). There was also support from the Ministry of Education and Science of the Russian Federation in the form of a subsidy for the implementation of certain activities under the Federal Scientific and Technical Program for the Development of Synchrotron and Neutron Research and Research Infrastructure during 2019–2027, approved by the Decree of the Government of the Russian Federation dated 16 March 2020 within the framework of the national project “Science and Universities”, as well as the grant provided for state support for the creation and development of the world-class genome research center “Kurchatov Genome Center”. There were two grants of the President of the Russian Federation for fundamental and applied scientific research in priority areas of science, technology and engineering of the Russian Federation for young Russian scientists – Candidates of Science and Doctors of Science.

In 2022, the employees of NRC “Kurchatov Institute” – PNPI defended 10 Candidate of Sciences dissertations, which is in line with the Program of Activities of NRC “Kurchatov Institute” – PNPI for 2018–2022.

Training of highly qualified personnel for five years

Year	Total number of dissertations / number of Doctor of Science dissertations
2018	8/2
2019	7/-
2020	9/3
2021	12/2
2022	10/-

NRC “Kurchatov Institute” – PNPI under the License to carry out educational activities (without time limitation) dated 02.06.2017 No. 2599 (L035-00115-47/00097282) and the State Accreditation Certificate dated 06.07.2020 No. 3414 (without time limitation) issued by the Federal Education and Science Supervision Service (Rosobrnadzor), performs training in accordance with higher education programs – programs of training of academic and teaching staff in postgraduate courses financed from the federal budget allocations.

Training of highly qualified personnel is provided in compliance with the requirements of the Federal State Educational Standards (FSES) of the higher education within the following training programs:

- 03.06.01 “Physics and Astronomy” within subfields:
 - 01.04.02 “Theoretical Physics”,
 - 01.04.07 “Condensed Matter Physics”,
 - 01.04.16 “Nuclear and Particle Physics”,
 - 03.01.02 “Biophysics”,
- 06.06.01 “Life Sciences” within subfields 03.02.07 “Genetics”;

in accordance with the Federal State Requirements (FST) for scientific specialties in accordance with the Nomenclature approved by the order of the Ministry of Education and Science of the Russian Federation dated 24.02.2021 No. 118:

- 1.3.3. “Theoretical Physics” (physico-mathematical sciences),
- 1.3.8. “Condensed Matter Physics” (physico-mathematical sciences),
- 1.3.15. “Nuclear and Particle Physics, High-Energy Physics” (physico-mathematical sciences),
- 1.5.2. “Biophysics” (physico-mathematical sciences),
- 1.5.4. “Biochemistry” (biological sciences),
- 1.5.7. “Genetics” (biological sciences),
- 3.3.3. “Pathophysiology” (biological sciences).

In 2022, the second graduation from Institute’s postgraduate program took place. Six graduation diplomas of postgraduate program were issued, which certify the completion of the third level of higher education in four fields of science:

“Theoretical Physics” (one diploma), “Condensed Matter Physics” (one diploma), “Nuclear and Particle Physics” (one diploma), “Genetics” (three diplomas).

In 2022, 13 students entered the full-time postgraduate program (in accordance with the target figures of admission (TFA) established by the order of the Ministry of Education and Science of the Russian Federation dated 29.04.2021 No. 46): eight students for the group of scientific specialties 1.3. “Physical Sciences” (TFA 03.06.00 “Physics and Astronomy” – eight persons), five students for the group of scientific specialties 1.5. “Life Sciences” (TFA 03.06.00 “Life Sciences” – five persons). The total number of postgraduate students by the end of 2022 amounted to 49 people.



In 2022, NRC “Kurchatov Institute” – PNPI took part in an open competition of the Ministry of Education and Science of the Russian Federation on the distribution of TFA for postgraduate course training financed from federal budget allocations for 2023/24. The following TFA were obtained in the groups of scientific specialties: 1.3. “Physical Sciences” – two places, 1.5. “Life Sciences” – one place.

In 2022, the proportion of young scientists (researchers without a degree, Candidates of Sciences under 35 years old and Doctors of Sciences under 40 years old) in the total number of employees involved in research and development amounted to 30%.

In 2022, 244 university students from Saint Petersburg’s (Saint Petersburg University (SPbU), Peter the Great Saint Petersburg Polytechnic University, and others) and other cities of the Russian Federation conducted academic and research work, did practical training, prepared final qualification works for Bachelor’s and Specialist’s degree and Master theses – in various departments of NRC “Kurchatov Institute” – PNPI.

The total number of students of field-oriented universities who did practical training in the Institute as part of implementing the Program of Activities of NRC “Kurchatov Institute” – PNPI for five years

Year	Number of students
2018	122
2019	127
2020	154
2021	175
2022	244

In 2022, five agreements were signed with new universities, the geography of trainees admission is expanding: Irkutsk National Research Technical University, Don State Technical University, Voronezh State University, Samara Polytech, Sevastopol State University. Already next year students will undergo practical training in the subdivisions of NRC “Kurchatov Institute” – PNPI. The Center for Personnel Training is responsible for organizing internships and placements.

In addition to internships, as a measure to attract young people, NRC “Kurchatov Institute” – PNPI implements a targeted enrollment of applicants in Russian universities, which guarantees employment of young specialists after graduation. Every year about 20 applications for participation in the targeted enrollment competition are submitted. In 2022, for example, nine contracts for targeted training were signed.

In an effort to popularize science and get young people interested in getting an education in the field of physics and biology, NRC “Kurchatov Institute” – PNPI organizes and conducts excursions to the Institute and to the facilities of NRC “Kurchatov Institute” – PNPI: tours to the accelerator facilities SC-1000 and C-80, PIK neutron facility, WWR-M reactor, the Molecular and Radiation Biophysics Division, other scientific divisions, and carries out occupational guidance for schoolchildren.

Under the agreement dated 28.12.2018 “On cooperation and joint activities” between the administration of the Gatchina Municipal District of the Leningrad Region and NRC “Kurchatov Institute” – PNPI and within the framework of existing cooperation agreements with educational institutions in Gatchina (Lyceum No. 3 Named after the Hero of the Soviet Union A.I. Peregudov, Secondary School No. 9 with in-Depth Study of Individual Subjects, Secondary School No. 2, Secondary School No. 7, Private Secondary School “Apeks”, institution of additional education “Center for Information Technologies”, municipal institution “Gatchina Centralized Library System”) employees of NRC “Kurchatov Institute” – PNPI are engaging schoolchildren in science, which includes delivering popular-science lectures, selecting of promising students and conducting practical training in physics, biology, chemistry, and mathematics.

As part of the national project “Education”, since November 2022 the Institute has been cooperating with the educational centers “Point of Growth” in schools of the Gatchina Municipal District – in Vyritsa, Druzhnaya Gorka, Bolshiye Kolpany, Pudost, Nikolskoye, Prigorodniy, Kommunar.

Since June 2022 the Institute takes part in the implementation of the project “Kurchatov Classes” on the basis of schools of Saint Petersburg – cooperation agreements were signed with the following schools: School No. 257 of the Pushkin District, School No. 631 of the Primorsky District, School No. 334 of the Nevsky District, School No. 703 of the Moskovsky District, School No. 406 of the Pushkin District, School No. 47 of the Petrogradsky District, Lyceum No. 395 of Krasnoselsky District, Lyceum No. 226 of Frunzensky District, School No. 171 of Central District, School No. 225 of Admiralteysky District, Lyceum No. 281 of Admiralteysky District, Lyceum No. 179 of Kalininsky District.

The Research and Educational Center of NRC “Kurchatov Institute” – PNPI organizes lectures, workshops, quizzes and extracurricular classes for the in-depth study of some topics in physics and biology for students of schools of Gatchina and Gatchina District, within the framework of which schoolchildren get acquainted with the achievements of modern science and technology. Professional guidance counseling is actively carried out with students of schools of Saint Petersburg, which includes popular science lectures (including off-site lectures in schools), excursions to the structural subdivisions of the Institute, promoting the achievements of Russian science and, thus, increasing interest in scientific professions in general and the activities of the Institute in particular. VR products are used for demonstrations, as well as interactive and physical mock-ups of stations developed by staff at the Center for Personnel Training.

Under the Collaboration Agreement between SPbU and NRC “Kurchatov Institute” – PNPI the employees of NRC “Kurchatov Institute” – PNPI conduct lectures and laboratory practicals in the frame of the academic program “Convergence and High-End Technologies” for students of 10th and 11th grade of Faddeev Academic Gymnasium of SPbU.

NRC “Kurchatov Institute” – PNPI carries out a unique project called “School Environmental Initiative” – “Young Talents” aimed at environmental education of children and teenagers. In 2022, a lot of creative contests, olympiads, environmental actions were held. Around three thousand young residents of Gatchina and Gatchina District took part in the project events.

Awards. Prizes

NRC “Kurchatov Institute” – PNPI is an actively functioning institution, which keeps pace with current world trends, as evidenced by numerous prizes and scholarships of its employees.

Active participation of the Institute’s employees in the competition for the **I.V. Kurchatov Prize** has already become a good tradition. It is particularly pleasant that not only leading and young scientists and engineers but also students are encouraged to participate in the competition.

In 2022, the list of Kurchatov Prize winners traditionally includes studies and teams of authors from NRC “Kurchatov Institute” – PNPI.

The work that won in the **field of scientific research** is titled “Method of Precise Theoretical Study of Materials Containing Lanthanides, Actinides and Transition Metals” and was performed in the Quantum Chemistry Laboratory of the ADD (A.V. Titov, Yu.V. Lomachuk, N.S. Mosyagin, D.A. Maltsev, V.M. Shakhova). Scientists have developed a precision compound-tunable embedding potential method (CTEP method) for modeling the electronic structure of materials containing *f*- (lanthanides and actinides) or heavy *d*-elements as periodically arranged atoms in the crystal or as impurity atoms. The methods known in the world for calculation of periodic structures allow, at best, to achieve an accuracy of ~ 0.1 eV for energy properties, which is insufficient for reliable calculation of compounds of *f*- and *d*-elements having atomic excitations at the same energy level, or even less. The winning approach aims for an accuracy of ~ 0.01–0.03 eV, in line with the capabilities of its constituents and other methods being developed at the Quantum Chemistry Laboratory.

The winner **among student papers** was Ekaterina Ivanova, “The Swiss Cheese Gene of *Drosophila Melanogaster* and Its Role in Spermatogenesis”, carried out at the MRBD. The work extends the currently available knowledge on the functions of the *swiss cheese* gene and shows for the first time the importance of its normal function in ensuring male fertility of *D. melanogaster*. As is well known, *Drosophila* is a favorite tool for geneticists to use in genetic modeling of some human diseases, including Parkinson’s, Huntington’s, and Alzheimer’s.

Dynamics of receiving the I.V. Kurchatov Prize by the employees of NRC “Kurchatov Institute” – PNPI for five years

Contest nomination	2018	2019	2020	2021	2022
In the field of scientific research	2	1	1	-	1
In the field of engineering and technological developments	1	-	-	-	-
Among the works of young scientists and engineers	3	1	2	3	-
Among the works performed by students	1	3	1	1	1
Total	7	5	4	4	2

In 2022, eight researchers of NRC “Kurchatov Institute” – PNPI were awarded **personal scientific scholarships of the Governor of the Leningrad Region for 2022–2023**: six researchers – in the “Leading Scientists” category and two researchers in the “Young Scientists” category.

Holders of scientific scholarships of the Governor of Leningrad Region in the “Leading Scientists” category:

- *O.Yu. Andreev*, leading researcher at the Quantum Chemistry Laboratory of the ADD;
- *E.S. Kropotova*, researcher at the Laboratory of Biopolymers of the MRBD;
- *V.T. Lebedev*, head of the Neutron Physical and Chemical Research Laboratory of the NRD;
- *S.N. Pchelina*, head of the Laboratory of Human Molecular Genetics of the MRBD;
- *O.V. Sirotkina*, leading researcher at the MRBD;
- *A.K. Fomin*, leading researcher at the Neutron Physics Laboratory of the NRD.

Holders of scientific scholarships of the Governor of Leningrad Region in the “Young Scientists” category:

- *A.E. Kopytova*, postgraduate student, MRBD;
- *V.A. Lyamkin*, researcher at the NRD.

On 17 March 2022, at NRC “Kurchatov Institute” – PNPI a solemn meeting of the Scientific Council of the Institute was held, which was dedicated to the 50th anniversary of naming the institution after B.P. Konstantinov (on 10 March 1972, by the order of the first director of Leningrad Institute of Nuclear Physics of the USSR Academy of Sciences Oleg Sumbaev on the basis of the Resolution of the Presidium of the USSR Academy of Sciences of 10.02.1972 No. 203 and in accordance with the Resolution of the Council of Ministers of the RSFSR of 20.01.1972 No. 49 the Institute was named after Boris Pavlovich Konstantinov).

The meeting included awarding the Institute’s employees with awards of the Ministry of Education and Science of Russia, the Governor of the Leningrad Region, NRC “Kurchatov Institute”, and the administration of the Gatchina Municipal District in honor of the 50th anniversary of the Institute.

Seven young employees of the Institute in accordance with the order of the Ministry of Science and Higher Education of the Russian Federation of 31.01.2022 No. 37 k/n were awarded the **badge “Young Scientist”**.

Sergey Smolsky, Deputy Director for Operation of Nuclear Installations of NRC “Kurchatov Institute” – PNPI, was awarded the **medal “For Merits in the Development of Atomic Energy”**. On 29 December 2022 the government award was presented to him by the Governor of the Leningrad Region Alexander Drozdenko.

Konstantin Ermakov, Deputy Head of the ADD, Candidate of Sciences in Physics and Mathematics, Chairman of the Gatchina Society “Residents of Blockaded Leningrad”, was awarded one of the highest awards of Gatchina – the **honorary badge “Gatchina – City of Military Glory”**. The corresponding decision was adopted by the City Council on 24 June 2022, the awarding ceremony took place on 22 November



2022 in the Gatchina Palace at a solemn meeting in honor of the 226th anniversary of Gatchina being granted the status of the city.

Names of the winners of an **award of the Governor of Leningrad Region** were announced on the eve of the New Year. This is the award recognizing “the contributions to the development of science and technology in the Leningrad Region” and “for the best research project”.

Yury Lomachuk, a researcher at the Quantum Chemistry Laboratory of the ADD, was awarded the prize for his contribution to the development of science and technology in the Leningrad Region in



the category “For Achievements in the Field of Digital and Information Technologies”. Deputy Chairman of the Government of the Leningrad Region, chairman of the Committee for Economic Development and Investment Activity Dmitry Yalov personally presented the award to the scientist on the Day of Russian Science, 8 February 2023.

For young scientists and specialists of NRC “Kurchatov Institute” – PNPI who demonstrate significant achievements in scientific research, a **scholarship program** was established in recognition of outstanding achievements and in memory of distinguished scientists S.E. Bresler,

V.N. Gribov, G.M. Drabkin, V.M. Lobashev, and A.A. Vorobyov (since 2022) whose academic careers are inextricably linked to the Institute. Scholarships are awarded annually in the following categories:

- Bresler scholarship for works in the field of biology,
- Gribov scholarship for works in the field of theoretical physics,
- Drabkin scholarship for works in the field of condensed matter physics,
- Lobashev scholarship for works in the field of nuclear physics,
- Vorobyov scholarship for works in high energy physics and elementary particle physics.



D.V. Chubukov

In 2022, five young scientists of the Institute were the recipients of these scholarships.

Bresler scholarship for works in the field of biology was awarded to senior laboratory assistant of the Laboratory of Experimental and Applied Genetics of the MRBD *L.A. Garaeva* (“Plant Vesicles as Carriers of Bioactive Molecules”).

Gribov scholarship for works in the field of theoretical physics was awarded to senior laboratory assistant of the TPD *V.P. Vandeev* (“Analysis of the Geodesic Deviation Equation in Static Spaces of Different Dimensionality”).

Drabkin scholarship for works in the field of condensed matter physics was awarded to junior researcher of the NRD *A.E. Susloparova* (“Study of Crystal Structure and Spin State Features of the Family of Tellurates A_2MnTeO_6 ($A = Li, Na, Ag, Tl$) by Neutron Diffraction”).

Lobashev scholarship for works in the field of nuclear physics was awarded to two young scientists: senior laboratory assistant of ADD *S.D. Prosnjak* (“Development of Theoretical Methods for Studying the Magnetization of Nuclei to Determine Magnetic Moments Using Electronic Structure Studies”) and senior laboratory assistant of the HEPD *V.V. Chulikov* (“Study of the Production of Charmed Baryons in High-Energy Proton–Proton Interactions”).

D.V. Chubukov continues to receive the **scholarship of the President of the Russian Federation for young scientists and postgraduates** engaged in promising research and development in priority areas of modernization of the Russian economy for 2021–2023 (SP-1213.2021.2 “Investigation



P.A. Melentiev

of Properties of Molecular Systems and Their Application to Search for *P, T*-odd Interactions in Nature”). *P.A. Melentiev* was the recipient of a **scholarship of the Government of the Russian Federation for full-time graduate and postgraduate students** for the academic year 2021/22. *O.I. Utesov* continued to receive support under the **grant from the President of the Russian Federation for state support of young Russian scientists** – candidates of sciences for scientific research MK-1366.2021.1.2 “Investigation of Properties of Spiral Magnets with the Dzyaloshinskii–Moriya Interface Interaction”.

In April 2022, in the Government of the Leningrad Region, the Governor of the Leningrad Region presented state awards of the Russian Federation and awards of the Leningrad Region to the best representatives of various branches of the national economy, social sphere, culture, and science.

The Governor of the Leningrad Region, Alexander Drozdenko, presented to *R.A. Niyazov*, an employee of the TPD, a certificate for the right to receive **grant from the President of the Russian Federation for state support of young Russian scientists – candidates of sciences** No. MK-2918.2022.1.2 in the scientific direction “Physical Sciences” on the topic “Theoretical Study of Noise Characteristics of Topological Quantum Interferometers”.

Professor, Doctor of Sciences in Physics and Mathematics, honorary worker of science and technology of the Russian Federation *Georgy Alkhazov*, chief researcher of the Elementary Particle Physics Laboratory of the HEPD was awarded with a **Certificate of Merit of the Government of the Russian Federation** for his great contribution to the development of science, engineering and technology, and many years of conscientious work.

At the competition of scientific works of NRC “Kurchatov Institute” – PNPI 2022, the commission considered 33 works in 8 directions: “Theoretical Physics”; “Low Energy Nuclear Physics”; “Biological Research”; “Condensed State Physics”; “High Energy Nuclear Physics”; “Methodological Research”; “Applied Research”; “Monographs and Textbooks”. Having performed an expert evaluation and comprehensive discussion of the works, the Commission decided to award **the honorary title “Best Work of NRC “Kurchatov Institute” – PNPI** to the work “Experiment “Neutrino-4” Search for Sterile Neutrino and Results of Measurements” (*A.P. Serebrov, V.G. Ivochkin, R.M. Samoilov, A.K. Fomin, V.G. Zinoviev, P.V. Neustroev, V.L. Golovtsov, S.S. Volkov, A.V. Chernyj, O.M. Zhrebtsov, M.E. Chaikovskii, A.L. Petelin, A.L. Izhutov, A.A. Tuzov, S.A. Sazontov, M.O. Gromov, V.V. Afanasiev, M.E. Zaytsev, A.A. Gerasimov, V.V. Fedorov*).

The following works were awarded first prizes:

- **In the field of low energy nuclear physics** “7-Order Enhancement of the Stern–Gerlach Effect of Neutrons Diffracting in a Crystal” (*V.V. Voronin, S.Yu. Semenikhin, D.D. Shapiro, Yu.P. Braginets, V.V. Fedorov, Ya.A. Berdnikov, A. Ioffe, M. Jentschel, V.V. Nesvizhevsky*);
- **In the field of high energy nuclear physics** “First Direct Observation of the Dead-Cone Effect in Quantum Chromodynamics in Hard Proton–Proton Interactions at the Large Hadron Collider” (*Yu.L. Dokshitser, S.I. Troyan, V.A. Khose, M.B. Zhalov, V.V. Ivanov, E.L. Kryshen, M.V. Malaev, V.N. Nikulin, A.Yu. Ryabov, V.G. Ryabov, Yu.G. Ryabov, A.V. Khanzadeev et al. (ALICE Collaboration)*);
- **In the field of condensed state physics** “Study of Magnetic Structures and Spin-Wave Dynamics in Multiferroic Ferroborates by Neutron Scattering” (*I.V. Golosovsky, A.I. Vasiliev, B.Z. Malkin, A.A. Mukhin, M.N. Popova, I.A. Gulim, E. Ressouche, M. Boehm*);



O.I. Utesov



A.Yu. Drozdenko (left)
and R.A. Niyazov



G.D. Alkhazov

- **In the field of biological research** “Exosomes are Transporters of the Therapeutic Exogenous Hsp70 Protein into Human Cells” (L.A. Garayeva, Yu.V. Kil, E.Yu. Varfolomeeva, N.A. Verlov, Yu.P. Garmay, S.B. Landa, V.S. Burdakov, A.G. Myasnikov, A.L. Konevega, T.A. Shtam);
- **In the field of methodological research** “Theory of Raman Scattering in Nanopowders of Non-Polar Nanocrystals” (O.I. Utesov, A.G. Yashenkin, S.V. Koniakhin, I.N. Terterov, A.V. Siklitskaya, D. Solnyshkov);
- **In the field of applied research** “A New Method for Chemical Uranium Enrichment by Light Isotopes” (V.G. Zinoviev, I.A. Mitropolsky, I.S. Okunev, D.A. Rumyantseva, A.P. Serebrov, P.A. Sushkov, T.M. Tyukavina, G.I. Shulyak);
- **Monographs and textbooks** “Transition Distribution Amplitudes and Hard Exclusive Reactions with Baryon Number Transfer” (K.M. Semenov-Tian-Shansky, B. Pire, L. Szymanowski).

Scientific Events

Institute Seminars

- 11 January. Nuclear seminar of the HEPD.** *V.G. Ryabov.* “Polarization Phenomena in Heavy Ion Collisions at LHC”.
- 13 January. Theoretical seminar on CSP.** *A.V. Syromyatnikov.* “Cluster Representation of Spin 1/2 Operators for Studying Exotic Phases and Spin Dynamics in Magnets. Part 3. The J_1 – J_2 Model on a Square Lattice”.
- 13 January. Joint seminar of the HEPD and the TPD.** *A.P. Serebrov.* “Sterile Neutrinos and the Neutrino Model $3 + 1$ from the View of Existing Experimental Data”.
- 18 January. Nuclear seminar of the HEPD.** *A.Yu. Egorov.* “Search for QCD Asymptotic BFKL Effects in CMS Experiment”.
- 20 January. Theoretical seminar on CSP.** *A.V. Syromyatnikov.* “Cluster Representation of Spin 1/2 Operators for Studying Exotic Phases and Spin Dynamics in Magnets. Part 4. Heisenberg Antiferromagnet on the Square Lattice in a Strong Magnetic Field”.
- 25 January. Nuclear seminar of the HEPD.** *D.E. Sosnov.* “MC Generators for Diffraction Hadronic and Nucleus Collisions at High Energies: EPOS–LHC, QGSJET II and PYTHIA”.
- 27 January. Joint seminar of the HEPD and the TPD.** *Yu.L. Dokshitzer.* “Radiative Energy Losses of Fast Quarks Crossing a Cold Nucleus or Hot Quark–Gluon Medium”.
- 1 February. Nuclear seminar of the HEPD.** *K.A. Ivshin.* “Distillation of a Ternary (H_2 , D_2 , HD) Mixture of Hydrogen Isotopes in the Framework of an Experiment on D^3He Mesocatalytic Synthesis”.
- 3 February. Theoretical seminar on CSP.** *A.V. Syromyatnikov.* “Cluster Representation of Spin 1/2 Operators for Studying Exotic Phases and Spin Dynamics in Magnets. Part 5. Heisenberg Antiferromagnet on the Triangular Lattice in a Strong Magnetic Field”.
- 10 February. Joint seminar of the HEPD and the TPD.** *D.S. Gorbunov* (Institute for Nuclear Research of RAS). “Light Sterile Neutrinos”.
- 15 February. Nuclear seminar of the HEPD.** *V.V. Chulikov.* “Investigation of Fragmentation Fractions in Proton–Proton Collisions”.
- 22 February. Nuclear seminar of the HEPD.** *D.V. Fedorov.* “Experiments at the ISOLDE Facility (CERN)”.
- 24 February. Joint seminar of the HEPD and the TPD.** *D.S. Gorbunov* (Institute for Nuclear Research of RAS). “Problems with Fitting the Cosmological Data in Λ CDM”.
- 1 March. Nuclear seminar of the HEPD.** *A.E. Shevel.* “Artificial Intelligence and Rising of Artificial Neural Networks”.
- 3 March. Joint seminar of the HEPD and the TPD.** *M.G. Kozlov.* “Search for the Variations of Fundamental Constants at Large Red Shifts”.
- 15 March. Nuclear seminar of the HEPD.** *M.E. Vznuzdaev.* “Measurement of the Proton Charge Radius. PRES and AMBER Experiments. Technical Features and Status”.

- 22 March. Nuclear seminar of the HEPD.** *V.V. Lukashovich.* “CP Violation in Neutron Transmission”.
- 24 March. Joint seminar of the HEPD and the TPD.** *F.F. Karpeshin* (Mendeleev Institute for Metrology). “The Non-Resonance Shake-Off Mechanism of the Neutrinoless Double Electron Capture in Nuclei”.
- 29 March. Nuclear seminar of the HEPD.** *O.V. Miklukho.* “Structure Observation in High-Momentum Spectra of Secondary Protons in Inclusive Scattering $^{12}\text{C}(p, p')X$ at Angles of 21 and 24.5° at 1 GeV (Momentum Intervals s4 and s5)”.
- 31 March. Joint seminar of the HEPD and the TPD.** *A.P. Serebrov.* “Sterile Neutrinos and Dark Matter”.
- 5 April. Nuclear seminar of the HEPD.** *S.I. Manaenkov.* “Role of Fermi Statistics in Glauber Scattering Amplitudes”.
- 7 April. Joint seminar of the HEPD and the TPD.** *M.I. Strikman.* “The Short-Range NN Correlations and EMC Effect”.
- 12 April. Nuclear seminar of the HEPD.** *O.E. Maev.* “New LHCb Detector after Modernization. Status and Perspectives”.
- 14 April. Joint seminar of the HEPD and the TPD.** *M.G. Ryskin.* “Dynamics of the Diffractive Dissociation in Hadronic Processes”.
- 19 April. Nuclear seminar of the HEPD.** *A.N. Soloviev.* “Sources of Polarized Deuterium Atoms and Ions in the PolFusion Experiment”.
- 21 April. Joint seminar of the HEPD and the TPD.** *V.A. Khoze.* “Top Quark Studies Is One of the Major Fields in Particle Physics”.
- 26 April. Nuclear seminar of the HEPD.** *D.V. Novinsky.* “The Lambda Hyperon Asymmetry and Polarization Measurements at the SPASCHARM Experiment (IHEP, Protvino)”.
- 27 April. Theoretical seminar of the ADD.** *I.A. Mitropolsky.* “Systematization of Nuclear Radii Based on Neuron Net Application with Fuzzy Logic”.
- 28 April. Joint seminar of the HEPD and the TPD.** *M.G. Ryskin.* “QCD Instanton in Diffractive Events”.
- 12 May. Joint seminar of the HEPD and the TPD.** *Yu.L. Dokshitzer.* “QCD -50”.
- 17 May. Nuclear seminar of the HEPD.** *V.A. Oreshkin.* “Recent Results on the Exchange of Color Singlets in pp collisions at the LHC”.
- 19 May. Joint seminar of the HEPD and the TPD.** *A.V. Shuvaev.* “Generating Function for Nucleus–Nucleus Scattering Amplitudes in Glauber Theory”.
- 24 May. Nuclear seminar of the HEPD.** *T.A. Shtam.* “Application of Boron Preparations for Increasing Efficiency of Radiation Sickness Therapeutics”.
- 26 May. Joint seminar of the HEPD and the TPD.** *V.A. Khoze.* “Coulomb Threshold Effects in the WW Production and Prospects of Precision Measurement of the W -Boson Mass”.
- 31 May. Nuclear seminar of the HEPD.** *N.A. Burmasov.* “Search for New Physics in Ultraperipheral Collisions at the Large Hadron Collider”.
- 7 June. Nuclear seminar of the HEPD.** *V.A. Guzej.* “Contribution of Ultraperipheral Collisions to Diffractive Proton–Nucleus Scattering at the LHC”.
- 14 June. Nuclear seminar of the HEPD.** *Than Naing Soe* (Lebedev Physical Institute of RAS). “Irradiated by Cosmic Rays Meteorite Olivines as a Tool Search for Superheavy Elements in Nature (Based on Doctoral Dissertation Materials)”.

- 16 June. Theoretical seminar on CSP.** *V.E. Timofeev.* “Dynamics of the Skyrmion Crystal in the Stereographic Projection Approach”.
- 16 June. Joint seminar of the HEPD and the TPD.** *Yu.L. Dokshitzer.* “QCD Jets”.
- 21 June. Nuclear seminar of the HEPD.** *I.B. Smirnov.* “Algebraic Methods for Reconstruction of Coordinates in Cathode Strip Chambers”.
- 28 June. Nuclear seminar of the HEPD.** *A.A. Dzyuba.* “Test of Lepton Universality in b -Hadron Decays”.
- 30 June. Joint seminar of the HEPD and the TPD.** *V.V. Fedorov.* “The Dynamic Neutron Diffraction and Enhanced Stern–Gerlach Effect for Neutrons in the Perfect Crystals”.
- 20 September. Nuclear seminar of the HEPD.** *Kh.U. Abraamyan* (Joint Institute for Nuclear Research). “Observation of Structures in Invariant Mass Spectra of Photon Pairs at ~ 17 and ~ 38 MeV/ c^2 ”.
- 22 September. Institute seminar.** *L.V. Grigorenko* (Joint Institute for Nuclear Research). “Studies of Exotic Nuclei at the ACCULINNA-2 Facility. Prospects for Low-Energy Nuclear Physics in the Russian Federation”.
- 27 September. Nuclear seminar of the HEPD.** *A.N. Nikitenko* (NRC “Kurchatov Institute” – ITEP). “Search for Extra Higgs Bosons at LHC”.
- 29 September. Joint seminar of the HEPD and the TPD.** *N.N. Nikolaev* (Landau Institute for Theoretical Physics of the RAS). “Spin of Particles in the Storage Rings (COSY, PTR, NICA) as an Axion Detector”.
- 6 October. Joint seminar of the HEPD and the TPD.** *Yu.G. Naryshkin.* “Search for a Dark Matter in DAMA/LIBRA and COSINE-100 Experiments”.
- 11 October. Nuclear seminar of the HEPD.** *V.V. Abramov* (NRC “Kurchatov Institute” – IHEP). “Polarization Phenomena at High Energies”.
- 13 October. Joint seminar of the HEPD and the TPD.** *Yu.L. Dokshitzer.* “Hadrons and High Energies (Part 1)”.
- 18 October. Nuclear seminar of the HEPD.** *E.V. Kuznetsova.* “Track Detectors Based on Straw Drift Tubes”.
- 19 October. Seminar of the ADD.** *A.M. Altmark* (Saint Petersburg Electrotechnical University “LETI”). “Acceleration of Protons in the Plasma Wakefield”.
- 25 October. Nuclear seminar of the HEPD.** *D.D. Shapiro.* “Experimental Search for New Types of Inter-nucleon Interactions Beyond the Standard Model Using Neutron Scattering”.
- 26 October. Seminar of the ADD.** *A.A. Zakharov.* “Cryosphere Studies of the Antarctica”.
- 27 October. Joint seminar of the HEPD and the TPD.** *Yu.L. Dokshitzer.* “Hadrons and High Energies (Part 2)”.
- 1 November. Nuclear seminar of the HEPD.** *L.K. Gladilin* (Lomonosov Moscow State University). “Studies of B -Physics in Experiment ATLAS at LHC”.
- 3 November. Joint seminar of the HEPD and the TPD.** *M.G. Ryskin.* “Hidden Problems in the Parton Analyses”.
- 8 November. Nuclear seminar of the HEPD.** *A.N. Dyachenko.* “Development of a Non-Equilibrium Hydrodynamic Approach to Describing the Emission of High-Energy Secondary Particles in Collisions of Heavy Ions of Intermediate Energies (from Collisions of Solitons to Dark Matter Production)”.
- 10 November. Joint seminar of the HEPD and the TPD.** *Yu.L. Dokshitzer.* “Hadrons and High Energies (Part 3)”.

15 November. Nuclear seminar of the HEPD. *S.I. Stepanov.* “Investigation of Value and Creation Mechanism of Atmospheric Plasmoid Charge”.

16 November. Seminar of the ADD. *Timur Aydemir* (Moscow Aviation Institute (National Research University)). “Composites Based on FeCo Nanoparticles: Preparation, Structure and Properties (Based on Materials of Candidate Dissertation)”.

17 November. Joint seminar of the HEPD and the TPD. *M.G. Ryskin.* “A Puzzle in the Proton’s Electric Generalized Polarizability That Remains Unresolved for Two Decades”.

22 November. Nuclear seminar of the HEPD. *Yu.M. Ivanov.* “Experiment on the Splitting of a Proton Beam by a Curved Crystal at the PNPI Synchrocyclotron”.

24 November. Institute seminar. *S.V. Grigoriev.* “Experimental Evidence for Logarithmic Fractal Structure in Deciduous Trees”.

24 November. Joint seminar of the HEPD and the TPD. *Yu.L. Dokshitzer.* “Hadrons and High Energies (Part 4)”.

29 November. Nuclear seminar of the HEPD. *V.G. Korolyov.* “Nonmaterial Basis of Life”.

1 December. Theoretical seminar on CSP. *D.A. Davletbaeva* (Saint Petersburg University). “Investigation of Viscosity Behavior Near the Point of Phase Transition to the Superfluid State”. *D.A. Evdokimov* (Saint Petersburg University). “Reduction of Feynman Diagrams in a Stochastic Model of Turbulence in High Dimensional Spaces”. *A.V. Trenogin* (Saint Petersburg University). “Development of Methods for the Calculation of Multi-Loop Diagrams in Dynamical Theories”.

1 December. Joint seminar of the HEPD and the TPD. *I.I. Strakovsky* (George Washington University, USA). “Experimental Tests of QCD Scaling Laws at Large Momentum Transfer in Exclusive Light-Meson Photo-production”.

6 December. Nuclear seminar of the HEPD. *A.V. Andreyanov.* “Study of Polarized dd -Fusion in the PolFusion Experiment. Motivation of the Experiment and Methods of Analysis of Experimental Data”.

8 December. Joint seminar of the HEPD and the TPD. *Yu.L. Dokshitzer.* “Hadrons and High Energies (Part 5)”.

15 December. Joint seminar of the HEPD and the TPD. *Yu.L. Dokshitzer.* “Hadrons and High Energies (Part 6)”.

Conferences, Schools, Meetings

Within the context of a wide variety of areas of scientific research conducted in NRC “Kurchatov Institute” – PNPI we are convening our own conferences, lecture courses and workshops attended by scientists from leading research centers of Russia and abroad.

In 2022, the Institute organized more than 15 scientific events (meetings, conferences, schools).

Scientific activities carried out in 2022 aimed at the professional development of young scientists

Name of the event	Dates	Place	Number of participants
Workshop on Inelastic Neutron Scattering “Spectrina-2022”	21–23 June	NRC “Kurchatov Institute” – PNPI (Gatchina)	> 40
VIII International Conference and XIV International School for Young Scientists and Specialists Named after A.A. Kurdyumov “Interaction of Hydrogen Isotopes with Structural Materials”	3–9 July	Kresttsy, Novgorod region	~ 100
II Summer School of the Council of Young Scientists and Specialists of NRC “Kurchatov Institute” – PNPI	26–28 August	Skamja, Slantsevsky district, Leningrad region	50
V School “Neutron Studies of Condensed Matter” (NIKONS-2022)	24–28 October	Saint Petersburg University (Saint Petersburg)	> 50
IX All-Russian Youth Science Forum with International Participation “Open Science 2022”	16–18 November	NRC “Kurchatov Institute” – PNPI (Gatchina)	> 220
VII Youth School of the PIK Reactor (Professionalism. Intellect. Career. “PIK-2022”)	19–30 September	NRC “Kurchatov Institute” – PNPI (Gatchina)	40
XI School on Polarized Neutron Physics “FPN-2022”	14–15 December	NRC “Kurchatov Institute” – PNPI (Gatchina)	> 50

Also, in 2022 the researchers of the Institute participated in more than 185 international and Russian conferences and gave around 470 talks as speakers.

Science News

On 18 May 2022, NRC “Kurchatov Institute” – PNPI hosted a joint meeting of the boards of the Ministry of Education of the Republic of Belarus, the State Committee on Science and Technology of the Republic of Belarus, the Ministry of Science and Higher Education of the Russian Federation, and the Ministry of Education of the Russian Federation. The event was dedicated to discussing the prospects for the development of the unified scientific, technological, and educational space of the Union State, as well as a joint plan for the implementation of youth policy.

Russian and Belarusian scientific organizations jointly conduct research in various fields, including biomedicine, nanosystems, nuclear energy, as well as in the transport and space industries.

Mikhail Kovalchuk, President of NRC “Kurchatov Institute”, noted that bridging the gap between Russian and Belarusian science is an important project for integrating the former Soviet republics into the unified research infrastructure. He added that this experience takes the shared heritage in the field of science to a whole new level.

Russia and Belarus have long shared close relations. Scientific ties, including in the field of mega-science, have been maintained very intensively. Contacts between universities were especially fruitful. “But today, in my opinion, our joint activity in science has been given a new lease of life”, said Mikhail Kovalchuk.



On 25–29 July 2022, the school-conference “Modern Problems of Chemical Physics and Theoretical Chemistry” organized jointly by Irkutsk State University (ISU) and NRC “Kurchatov Institute” – PNPI took place in the village of Bolshiye Koty on the shore of Lake Baikal. It was attended by 45 speakers from Saint Petersburg, Moscow, Nizhny Novgorod, and Irkutsk.

The first working session opened with a series of oral presentations on the development of new materials based on nanotubes and fullerenes. Fullerene molecules are convex closed polyhedra formed by twenty or more carbon atoms (the most common are the C_{60} and C_{70} molecules).

A considerable part of the presentations was connected with the study of atoms and compounds of heavy and superheavy elements, which represent a real challenge for the theory, first of all, due to

the necessity to take into account relativistic effects. Scientists from NRC “Kurchatov Institute” – PNPI presented the results of research in the field of development of both original computational approaches and their consistent application for the precision description of electron density of lanthanides and transuranium elements. The talks devoted to the search of possible violations of P and T symmetry of space and time caused a lively discussion. The talk that started this discussion had a symbolic title: “The Search for New Physics with Molecules”.

Scientists of NRC “Kurchatov Institute” – PNPI took part in the International Conference on Neutron Scattering ICNS-2022, which was held from 21 to 25 August in Buenos Aires (Argentina). ICNS is the world’s largest forum for scientists practicing neutron scattering at megaclass research facilities. The ICNS conference is held every four years. It attracts scientists from almost all over the world – Australia, the Americas, Europe, and Asia.

ICNS-2022 has become the largest international platform for sharing the latest outstanding achievements in neutron scattering science, including a wide range of topics, namely soft matter science, biology and biotechnology, condensed matter physics, magnetism and superconductivity, solid state chemistry, energetics, structural and functional materials science, neutron physics, and finally, neutron facilities and neutron sources.

It was the first major post-Covid neutron conference. It took place in a hybrid format with 360 participants online, and 190 scientists who traveled to Buenos Aires to participate in direct, face-to-face discussions within this forum. Russia was represented by about 20 scientists from neutron centers of Saint Petersburg, Dubna, and Yekaterinburg. Scientists from NRC “Kurchatov Institute” – PNPI presented more than 20 oral and poster reports. Researchers of NRC “Kurchatov Institute” – PNPI gave seven reports on their achievements in the field of creating new stations on the PIK reactor, four reports related to life sciences, and three reports related to the study of magnetic materials.



Specialists of NRC “Kurchatov Institute” – PNPI took part in the pedagogical accelerator. On 26–27 August 2022 the Pedagogical Accelerator 2022–2023 was held in the “Zerkalny” suburban children’s activity center. It was an off-site seminar for heads of general education organizations that had been awarded with grants from the Government of Saint Petersburg for equipping general education organizations with modern teaching aids. The seminar was organized by the Committee on Education of the Government of Saint Petersburg, the Academy of Postgraduate Pedagogical Education and the Center for Regional and International Cooperation.

Since 2021, to improve the quality of general education, state general education organizations of Saint Petersburg have been provided with grant support to equip them with modern teaching and learning aids. Thanks to this, pre-professional classes in the following areas are being created in 95 general education organizations of Saint Petersburg, which are grant recipients in 2021 and 2022: “Engineering Class”, “IT Class”, “Humanities and Technology Class”, “Chemical and Biological Class”, “Medical Class”, “Pedagogical Class”, “Cadet Class”, and “Mediaclass”. Since September 2022, pre-professional classes designated as the “Kurchatov Class” will be opened in five general education organizations

of Saint Petersburg. NRC “Kurchatov Institute” – PNPI will act as a scientific partner for organizations with pre-professional classes in the direction “Kurchatov Class”. Pre-professional classes make it possible to integrate general and supplementary education so that schoolchildren could easily orient themselves when making a professional choice of their further educational route.



An outdoor event II Summer School of the Council of Young Scientists and Specialists of NRC “Kurchatov Institute” – PNPI was held on 26–28 August 2022. The School is gradually acquiring the status of an annual event, which gives managers the opportunity to encourage young employees who had demonstrated a good performance in the professional and social life of the Institute during the year.

The School began with a business game “Improve Your Personal Effectiveness” organized by the members of the Council of Young Scientists and Specialists (CYSS). The program of the School consisted of several sections:

“Current Topics and Projects of NRC “Kurchatov Institute” – PNPI”, “Youth Policy in NRC “Kurchatov Institute” – PNPI” and “Ecology in NRC “Kurchatov Institute” – PNPI”.

As part of the discussion of youth policy in the Institute, the Chairman of the CYSS N.A. Petrova held a dialog with the participants of the School on the topic “What is Youth Policy and Ways of Its Development in NRC “Kurchatov Institute” – PNPI” and Head of the Center for Personnel Training S.A. Sheka on “Career Opportunities for Young Employees of the Institute or How to Improve Your Qualifications for Free”. A module of lectures was followed by a round table was organized to discuss methods of non-financial motivation of young scientists and specialists. The organizers of the School plan to bring the results of the discussions to the management of the Institute.

From 19 to 30 September, VII Youth School of the PIK Reactor (Professionalism. Intellect. Career. “PIK-2022”) was held at the Center for Personnel Training (CPT) of NRC “Kurchatov Institute” – PNPI.

Participants had a lot of activities to attend. The organizers aimed to include in the program of the School not only practical professional knowledge, but also sessions aimed at developing personal skills.

During the first week of training, colleagues from Yekaterinburg hosted a series of webinars for the participants. During five days, attendees of the School studied the basics of time management, emotional intelligence, principles of communication, self-presentation and feedback, learned how to prevent burn-out in the workplace. Small practical tasks were given after each lecture. As a result, a rating system was established, based on which the most active and diligent participants were identified and awarded valuable prizes.

The second week was held in the traditional format – participants listened to lectures by guest lecturers on safety culture at nuclear facilities. This important and relevant topic caused many clarifying questions to the lecturers and “behind-the-scenes” discussions among the School participants, many of whom work directly with ionizing radiation sources.

On the last day of the Youth School, the participants took a test on the material covered, received certificates and posed for photographs.





NRC “Kurchatov Institute” – PNPI became another platform of the 35th meeting of the International Association of Academies of Sciences (IAAS) Council, which had started in Moscow on 26 September.

On 29 September, the Council participants visited the PIK reactor facility and the biological complex of NRC “Kurchatov Institute” – PNPI, where they got acquainted with the advanced achievements of Russian scientists in the fields of nuclear physics and biophysics.

On 30 September, NRC “Kurchatov Institute” – PNPI hosted the 1st meeting of the Public Council of the CIS base organization on the development of research infrastructure of the “megascience” class. It was attended by about 40 people, including heads of leading universities and research institutes of Russia, Armenia, Belarus, Kazakhstan, Kyrgyzstan, Tajikistan. The meeting was chaired by Mikhail Kovalchuk, President of the National Research Center “Kurchatov Institute”.

The participants of the meeting discussed the possibilities of scientific organizations of the CIS member states in the field of research infrastructure of the “megascience” class. These are facilities for synchrotron and neutron research, research reactors, high-performance computing complexes – everything that ensures the creation of the most modern and ready for new challenges scientific landscape in the post-Soviet territory.

From 24 to 28 October 2022, NRC “Kurchatov Institute” – PNPI, together with Saint Petersburg University (SPbU) organized and conducted the V School “Neutron Studies of Condensed Matter” NIKONS-2022. The school was held in person at the Department of Nuclear Physics Research Methods of SPbU (Peterhof). All lectures and workshops were broadcast online and made available to a wide audience on the Internet.

The NIKONS School has been held for the fifth year already and is designed to introduce a wide range of young scientists to the methods of neutron scattering in physics and condensed matter research.

The audience of the school consists of graduate students of natural sciences, postgraduate students and young specialists who are already conducting experimental research in the field of condensed matter, but are not yet familiar with the methods of neutron scattering. SPbU invited colleagues from the Institute of Metals Physics of the Ural Branch of the Russian Academy of Sciences (Yekaterinburg) to the NIKONS-2022 School to improve the skills and expand the horizons of young employees involved in the development of the concept and design of neutron stations for the compact pulsed neutron source DARIA. In total, 49 participants registered for the School: 16 students and 27 young scientists.





During the autumn break, from 28 October to 3 November, a profile scientific shift “Kurchatov Codes” was held for students of seven Saint Petersburg schools for the first time. In a number of general education organizations in Saint Petersburg pre-professional classes in the direction of “Kurchatov Class” are being created in partnership with NRC “Kurchatov Institute” – PNPI.

During the week, 125 high school students from these schools listened to lectures, performed practical tasks, participated in master classes and round tables.

The profile shift “Kurchatov Codes” was held within the framework of the cooperation agreement between the Government of Saint Petersburg and NRC “Kurchatov Institute”. Classes for the children were conducted by employees of NRC “Kurchatov Institute” – PNPI and NRC “Kurchatov Institute”.

The IX All-Russian Youth Scientific Forum with International Participation “Open Science 2022” was held at NRC “Kurchatov Institute” – PNPI from 16 to 18 November. In total, more than 220 people from different parts of Russia took part in the forum this year.

The main advantage of the “Open Science” Forum is the opportunity to get acquainted with new relevant directions, technologies, as well as to present the results of your work to the scientific community. Over the nine years of its existence, the forum has got up steam and has become a powerful platform for the exchange of experience among young scientists.

The main directions of the forum in 2022 are atomic and particle physics, theoretical physics, condensed matter physics, physics and technology of reactors and accelerators, biophysics, biomedicine, genetics, materials science and nanostructured materials. A separate event of the forum is the microsposium of the Kurchatov Genomic Center – PNPI “Bioinformatics, Bioengineering, Genetic Technologies”.



On 17 November, there was an award ceremony of the winner of the second video contest “Science Talk” (Speak Openly about Science – 2022) – Samir Mageramov, student of 11th grade of Gatchina General Secondary School No. 9.

Samir submitted a video about the process of his work on a book about sedentary birds of the Leningrad Region. It is worth noting that the book itself is a real masterpiece of applied art, calligraphy, created on the basis of unique information about the life of wintering birds of the Leningrad Region collected by the young author. The author says that the project took him a full

11 months to complete. Samir is the only contestant who fulfilled all the contest requirements flawlessly and from the first attempt. In addition, the jury’s decided in favor of Samir, since the topic of his project corresponds to the environmental topic, which is developed and promoted by NRC “Kurchatov Institute” – PNPI.

Last year Samir had already become the prize-winner the “Science Talk” contest. Then he had taken the third place with the work “A Book about Medicinal Plants of the Leningrad Region”, and this year he managed to improve his result.

Samir received a valuable prize for winning the competition from Sergey Gorchakov, Director of NRC “Kurchatov Institute” – PNPI. Awarding the winner, the director congratulated Samir on his victory, noted the high quality of the work he had done, praised his persistence and expressed confidence that Samir’s next award would be of an even higher level.



The project implemented by the Scientific and Educational Center of NRC “Kurchatov Institute” – PNPI has entered its active phase. The project is carried out within the framework of cooperation agreements with educational centers “Point of Growth” established in rural schools of Gatchina Municipal District within the framework of the national project “Education”. On 23 November 2022, the Institute signed agreements, under which it officially acts as a social partner of schools involved in the project and will expand the scope of lecture, excursion and practical work with students,

provide scientific support to the centers, as well as participate in thematic shifts “Engineering Camp”. One of the main goals of the network project is to increase the educational potential of students in science-oriented programs.

On 13 December 2022, the first lecture “Prospects of Modern Biology” by Dr. Andrei Chernenkov, Head of the Department of Education, Candidate of Biological Sciences, was held on the basis of the “Point of Growth” in Secondary General School in Pudost. Students from all “Points of Growth” centers in the Gatchina Municipal District, as well as network schools of these centers, listened to the lecture via video conference. A total of 350 Gatchina schoolchildren from grades 8 to 11 took part in the lecture.

From 1 to 3 December 2022, the II Congress of Young Scientists was held at the Sirius Park of Art and Science in Sochi. This large-scale event, which has already been named the key event of the first year of the Decade of Science and Technology, aims to popularize science, attract young scientists to the field of research and development, and use science to solve important tasks of the state. The forum was attended by young scientists from different regions of Russia, heads of scientific organizations, representatives of the state and business, rectors of leading universities. Employees of NRC “Kurchatov Institute” – PNPI also took part in the forum. The event brought together more than 3 000 participants from Russia and several dozen other countries, thereby creating a unique atmosphere for communication, exchange of ideas, trends, and experience.



The forum had a very busy agenda: expert sessions, panel discussions, round tables, scientific reports, and lectures. Within the framework of the business program, events on more than 10 topics were held simultaneously. The key topics for discussion were climate, nature-like technologies, development of engineering and mathematical education, maintaining food security, provision of passenger air com-

munication, support for young scientists, artificial intelligence, electronics, development of the Arctic, Siberia and the Far East, medicine.

NRC “Kurchatov Institute” – PNPI also presented at the exhibition stand of the Congress some of its best experimental developments – the optical section of the neutron-guide system of the PIK research facility, as well as experimental units of the test neutron reflectometer (TNR).

On the last day of the Congress there was another event that filled us with pride for NRC “Kurchatov Institute” – PNPI. As part of the business program, Leonid Skripnikov, Senior Researcher at the Laboratory of Quantum Chemistry, was solemnly presented with a certificate and a badge of the Russian Federation presidential science and innovation award for young scientists for 2021. The awards were presented by Andrei Fursenko, Assistant to the President of the Russian Federation.

The traditional final conference on the program “School Environmental Initiative” – “Young Talents 2022” was held in NRC “Kurchatov Institute” – PNPI.

After a break due to Covid restrictions, the conference returned to its usual face-to-face format: about 260 children from five years old and older from different educational institutions of Gatchina, Gatchina District and Saint Petersburg filled the conference hall with their laughter and wonderful concert performances. All of them are laureates and winners of the 2nd stage of the art and literary contest “School Environmental Initiative”, i. e. the very heroes of the holiday: young artists and writers who love and protect their planet. The event was also attended by senior friends of the environmental movement – deputies, public representatives, the administration of the Gatchina Municipal District was represented by M.V. Kravchuk, deputy head of the administration for social development.



of Metal Physics of the Ural Branch of RAS, Joint Institute for Nuclear Research, Saint Petersburg University, and other leading institutes.

XI School on Polarized Neutron Physics “FPN-2022” took place at NRC “Kurchatov Institute” – PNPI on December 14 and 15, 2022. The scientific scope of this year’s FPN School covered areas of physics such as topical problems for polarized neutron physics, polarized neutron techniques, small-angle scattering, reflectometry, polarized neutron diffraction, and neutron scattering instruments. The School was attended by about 60 scientists from NRC “Kurchatov Institute” – PNPI, M.N. Mikheev Institute

Materials courtesy of the press center of the Institute